

Diffuse sensors fiber optics

FUF 050B4006

dimension drawing

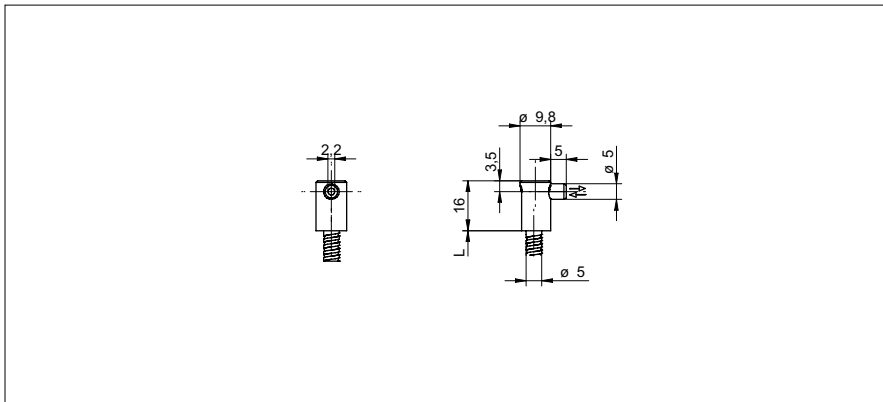

general data

particular characteristics	heat resistant side view
type	Diffuse sensors
sensing distance Tw	1 ... 25 mm
response time / release time	0,1 ... 1 ms
type of head (fiber optic cable)	cylindrical smooth (radial)
width / diameter (head)	9 mm
height / length (head)	16 mm
material (head)	aluminum
bending radius	12 mm (stat.) 24 mm (dynam.)
cable jacket diameter	4 mm
material cable jacket	brass chromium plated
fiber cross section	0,5 mm ²
material (fiber optic cable)	glass
length (fiber optic cable)	500 mm
operating temperature	-25 ... +120 °C

photo



Sensing distance/response time:
For the definitive sensing distance/response time please see table below "fitting fiber optic sensors".

fitting fiber optic sensors	sensing distance Tw (0,1 ms)	sensing distance Tw (0,25 ms)	sensing distance Tw (0,5 ms)	sensing distance Tw (1 ms)
FVDM 15	1 ... 22 mm	-	-	1 ... 25 mm