

Torque arm, 1-arm (mounting kit 054)

Article number: 11066077

Overview

- For low-dynamic applications and constant movements

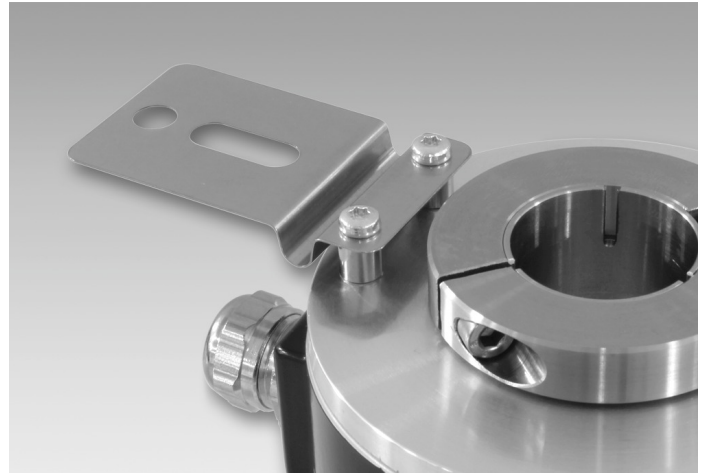

Technical data

Technical data - mechanical design

Weight approx. 8 g

Description

Torque support onto encoder by help of the attached screws. Push encoder onto the drive shaft and mount torque support onto the client side. Fastening clamping ring with clamping ring screw.

Scope of delivery

Torque support, two screws M3 x 12 (ISO 14583 - TX10) with two spacers 7 mm

Dimensions

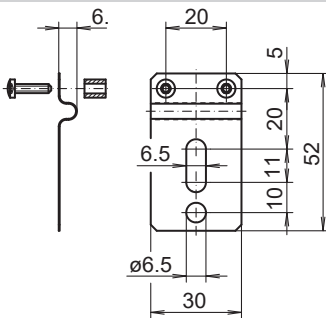

Assembly drawing

