

TE2

Compact RTD temperature sensor

TE2-#.###.#.###.#.0

Overview

- Compact and rugged design
- Customer-specific immersion depth down to 3000 mm
- Precision measurement from -50 ... 250 °C
- Integrated 4 ... 20 mA transmitter or Pt100 output
- Easy process implementation from DN 25 or in tank



Picture similar



EN 50155

Technical data

Performance characteristics

Pt100 accuracy class (EN 60751)	1/1 B ± (0.3 + 0.005 × t) °C
	1/1 A ± (0.15 + 0.002 × t) °C
	1/3 B ± 1/3 × (0.3 + 0.005 × t) °C
	1/6 B ± 1/6 × (0.3 + 0.005 × t) °C

Thermal response time, T50	RTD element only
	≤ 1.0 s , conical sensor
	≤ 1.3 s , Ø3 mm
	≤ 2.5 s , Ø4 mm
	≤ 3.0 s , Ø6 mm

Thermal response time, T90	RTD element only
	≤ 3.0 s , Ø3 mm
	≤ 3.6 s , Ø4 mm
	≤ 8.5 s , Ø6 mm

Process pressure Refer to section "Operating conditions"

Process temperature Refer to section "Operating conditions"

Process connection

Connection variants Refer to section "Dimensional drawings"

Sensor length ≤ 3000 mm

Sensor diameter outside Ø 6 mm

Mounting position Any, top, bottom, side

Standard response tip Ø 6 mm

Fast response tip Ø 3 mm
Ø 4 mm

Sensor tube material AISI 316L (1.4404)

Surface roughness wetted parts Ra ≤ 0.8 µm

Ambient conditions

Operating temperature range -40 ... 125 °C , with Pt100
-40 ... 85 °C , with transmitter

Storage temperature range -55 ... 90 °C

Ambient conditions

Degree of protection (EN 60529) IP 65 , with DIN EN 175301-803 A (DIN 43650 A), 4-pin
IP 68 , with M12-A, 4-pin and appropriate cable

Humidity ≤ 100 % RH , condensing

Long-term test (transmitter) IEC 770 6.3.2

Vibration (sinusoidal) (EN 60068-2-6) 1.6 mm p-p (2 ... 25 Hz), 4 g (25 ... 100 Hz), 1 octave / min.

Output signal

Without transmitter 1 x Pt100, 4-wire

With transmitter 4 ... 20 mA , 2-wire

Housing

Style Compact transmitter

Overall size Refer to section "Dimensional drawings"

Material AISI 304 (1.4301)

Electrical connection

Connector DIN EN 175301-803 A (DIN 43650 A), 4-pin
M12-A, 4-pin

Power supply

Voltage supply range 8 ... 35 V DC

Power-up time < 20 s

Reverse polarity protection Yes

Factory settings

Output range 0 ... 150 °C

Damping 0 s

Output at sensor fault 23 mA

TE2

Compact RTD temperature sensor

TE2-#.###.####.####.0

Technical data

Compliance and approvals

EMC	EN 61000-6-2 EN 61000-6-3 EN 61326-1 NE21
-----	--

Compliance and approvals

Hygiene	FDA (21 CFR 177.2415) 3-A (74-07)
Railway applications	EN 50155
Explosion protection	Ex ia Simple apparatus, gas and dust

Transmitter

Input

Measuring unit	°C °F
Min. measuring span	25 °C
Sample time	< 0.7 s
Accuracy	< 0.25 °C , @ ≤ 100 °C
Repeatability	< 0.1 °C
Resolution	14 bit
Ripple immunity	IEC 770 6.2.4.2
Error detection delay	< 10 s
Offset adjustment	± 10 °C , max.
Isolation, sensor to case	50 V AC , test 500V
Protection	± 35 V DC
Suppression	50 Hz 60 Hz

Output

Output signal	4 ... 20 mA , 2-wire
Accuracy	< 0.1 % , measuring span < 0.016 mA
Temperature drift	< 0.003 %/K , typ. < 0.01 %/K , max.
Resolution	12 bit
Effect of variations in supply voltage	< 0.01 %/V
Ripple immunity	3 Vrms
Shunt resistance	$R_s \leq (V_{DC} - 8 V)/0.023 A$
Damping	0.0 ... 30.0 s , programmable
Up/Down scaling limits	23 mA / 3.5 mA

Operating conditions

Ordering key	Process connection	BCID	Process pressure (bar)	Continuous	Process temperature with
				Process temperature Standard @ Tamb ≤ 20 °C (° C)	cooling neck, @ Tamb ≤ 20 °C (° C)
TE2-#.1.####.####.#	Tube without connection Ø 6	T65	-1 ... 40	-50 ... 125	-50 ... 250
TE2-#.3.####.####.#	G 1/2 A ISO 228-1	G06	-1 ... 100	-50 ... 125	-50 ... 250
TE2-#.4.####.####.#	G 1/2 A hygienic	A03	-1 ... 40	-50 ... 125	-50 ... 250
TE2-#.5.####.####.#	M12 × 1.5 hygienic	A02	-1 ... 40	-50 ... 125	-50 ... 250
TE2-#.6.####.####.#	M12 × 1.5 hygienic, PEEK cone	A02	-1 ... 10	-50 ... 115	N/A
TE2-#.7.####.####.#	G1/8 ISO 228/1 female thread, Hygienic	A01	-1 ... 40	-50 ... 125	-50 ... 250
TE2-#.8.####.####.#	G 1/4 A DIN 3852-E	G50	-1 ... 100	-50 ... 125	-50 ... 250
TE2-#.9.####.####.#	ISO 2852 (Tri-Clamp), DN 33.7; 38, Ø 50.5	C04	-1 ... 40	-50 ... 125	-50 ... 250
TE2-#.A.####.####.#	Tri-Clamp, DN3/4", Ø25.0	C01	-1 ... 40	-50 ... 125	-50 ... 250
TE2-#.B.####.####.#	BHC 3A DN 38	B01	-1 ... 40	-50 ... 125	-50 ... 250
TE2-#.D.####.####.#	1/2-14 NPT	N02	-1 ... 100	-50 ... 125	-50 ... 250
TE2-#.E.####.####.#	1/4-18 NPT	N01	-1 ... 100	-50 ... 125	-50 ... 250
TE2-#.F.####.####.#	G 1/2 A DIN 3852-E	G51	-1 ... 100	-50 ... 125	-50 ... 250
TE2-#.G.####.####.#					

For further information on permissible process and ambient temperatures, please refer to the operating instructions.

TE2

Compact RTD temperature sensor

TE2-#.###.#####.0

Compliance and approvals

Ordering key	Process connection	BCID	EN 10/2011	EN 1935/2004 EN 2023/2006	FDA	3-A
TE2-#.1.#####.##	Tube without connection Ø 6	T65				
TE2-#.3.#####.##	G 1/2 A ISO 228-1	G06				
TE2-#.4.#####.##	G 1/2 A hygienic	A03		■		
TE2-#.5.#####.##	M12 × 1.5 hygienic	A02		■		
TE2-#.6.#####.##	M12 × 1.5 hygienic, PEEK cone	A02	■	■	■	
TE2-#.7.#####.##	G1/8 ISO 228/1 female thread, Hygienic	A01		■		
TE2-#.8.#####.##	G 1/4 A DIN 3852-E	G50				
TE2-#.9.#####.##	ISO 2852 (Tri-Clamp), DN 33.7; 38, Ø 50.5	C04		■		■
TE2-#.A.#####.##	Tri-Clamp, DN3/4", Ø25.0	C01		■		■
TE2-#.B.#####.##	BHC 3A DN 38	B01		■		■
TE2-#.D.#####.##	1/2-14 NPT	N02				
TE2-#.E.#####.##	1/4-18 NPT	N01				
TE2-#.F.#####.##						
TE2-#.G.#####.##	G 1/2 A DIN 3852-E	G51				

The requirements of the respective 3-A Sanitary Standard will be only fulfilled in combination with appropriate mounting accessories. Those are marked with the 3-A logo.

Dimensional drawings (mm)

Housing

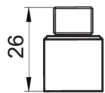

Housing with connector M12-A, 4-pin

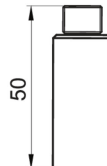

Housing with transmitter and connector M12-A, 4-pin

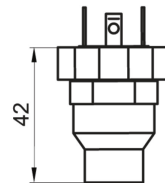

Housing with connector DIN EN 175301-803 A (DIN 43650 A), 4-pin

TE2

Compact RTD temperature sensor

TE2-#.###.#.#.#.#.0

Dimensional drawings (mm)

Housing

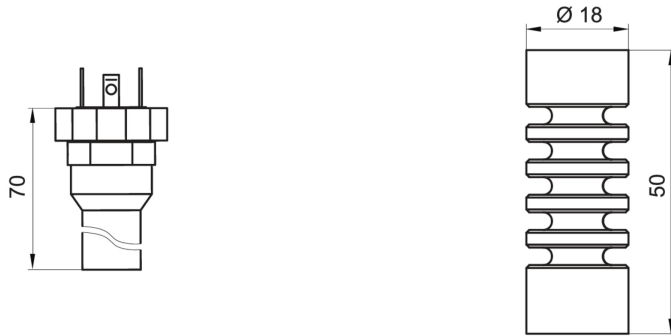

Housing with transmitter and connector DIN EN 175301-803 A (DIN 43650 A), 4-pin

Cooling neck

Process connection

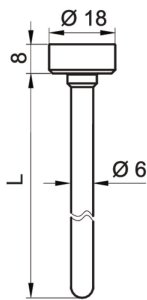

Without thread (BCID: T65)

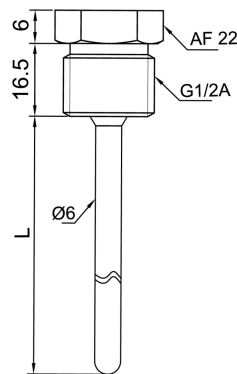

G 1/2 A ISO 228-1 (BCID: G06)

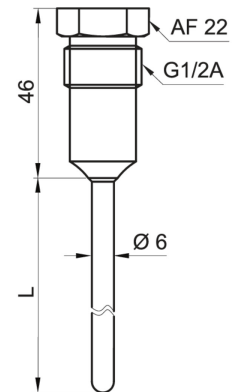

G 1/2 A hygienic (BCID: A03)

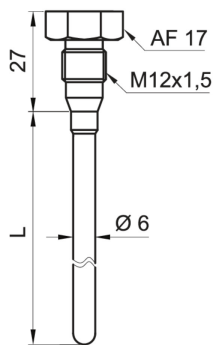

M12 x 1.5 hygienic (BCID: A02)

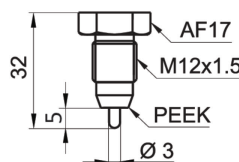

M12 x 1.5 hygienic, PEEK cone, tip Ø 3 x 5 mm (BCID: A02)

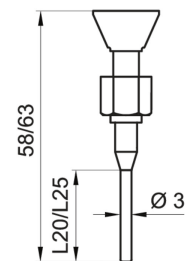

G 1/8 female thread hygienic (BCID: A01)

TE2

Compact RTD temperature sensor

TE2-#.###.#.###.#.0

Dimensional drawings (mm)

Process connection

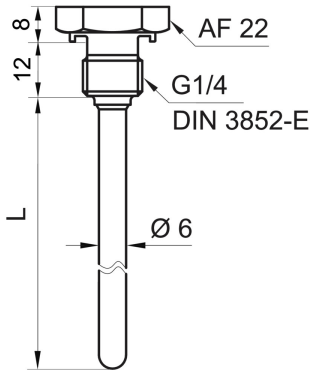

G 1/4 A DIN 3852-E (BCID: G50)

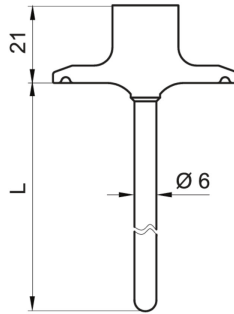

Tri-Clamp Ø 50.5 (BCID: C04)

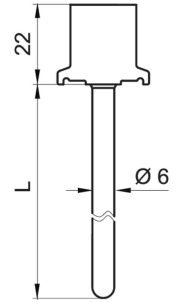

Tri-Clamp Ø 25 (BCID: C01)

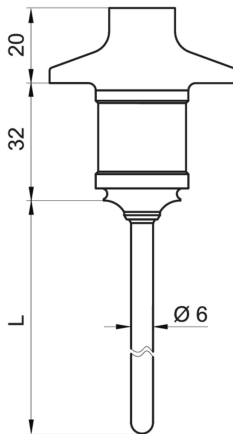

BHC 3A DN 38 (BCID: B01)

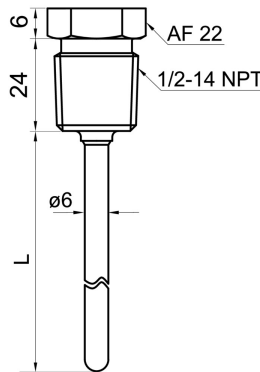

1/2-14 NPT (BCID: N02)

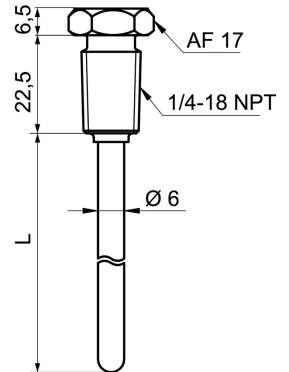

1/4-18 NPT (BCID: N01)

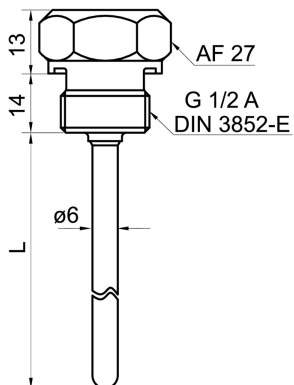

G 1/2 A DIN 3852-E (BCID: G51)



Standard response tip

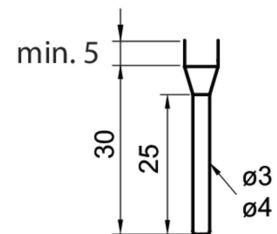

Fast response tip

TE2

Compact RTD temperature sensor

TE2-#. #. #####. #####.0

Electrical connection

Output type	Electrical connection	Equivalent circuit	Function	Pin assignment									
M12-A, 4-pin, stainless steel													
Pt100 (Single element)			<table border="1"> <tr><td>Pt100 11</td><td>1, 2</td></tr> <tr><td>Pt100 12</td><td>3, 4</td></tr> <tr><td>Frame ground</td><td>Plug thread</td></tr> </table>	Pt100 11	1, 2	Pt100 12	3, 4	Frame ground	Plug thread				
Pt100 11		1, 2											
Pt100 12		3, 4											
Frame ground		Plug thread											
Pt100 (Double element)		<table border="1"> <tr><td>Pt100 11</td><td>1</td></tr> <tr><td>Pt100 12</td><td>4</td></tr> <tr><td>Pt100 21</td><td>2</td></tr> <tr><td>Pt100 22</td><td>3</td></tr> <tr><td>Frame ground</td><td>Plug thread</td></tr> </table>	Pt100 11	1	Pt100 12	4	Pt100 21	2	Pt100 22	3	Frame ground	Plug thread	
Pt100 11	1												
Pt100 12	4												
Pt100 21	2												
Pt100 22	3												
Frame ground	Plug thread												
4 ... 20 mA, 2-wire, Iout at pin 2		<table border="1"> <tr><td>+Vs</td><td>1</td></tr> <tr><td>Iout</td><td>2</td></tr> <tr><td>N.C.</td><td>3, 4</td></tr> <tr><td>Frame ground</td><td>Plug thread</td></tr> </table>	+Vs	1	Iout	2	N.C.	3, 4	Frame ground	Plug thread			
+Vs	1												
Iout	2												
N.C.	3, 4												
Frame ground	Plug thread												
4 ... 20 mA, 2-wire, Iout at pin 2, 3		<table border="1"> <tr><td>+Vs</td><td>1</td></tr> <tr><td>Iout</td><td>2, 3</td></tr> <tr><td>N.C.</td><td>4</td></tr> <tr><td>Frame ground</td><td>Plug thread</td></tr> </table>	+Vs	1	Iout	2, 3	N.C.	4	Frame ground	Plug thread			
+Vs	1												
Iout	2, 3												
N.C.	4												
Frame ground	Plug thread												
DIN EN 175301-803 A (DIN 43650 A), 4-pin													
Pt100 (Single element)			<table border="1"> <tr><td>N.C.</td><td>1</td></tr> <tr><td>Pt100 11</td><td>2</td></tr> <tr><td>Pt100 12</td><td>3</td></tr> <tr><td>Frame ground</td><td>Grounding lug</td></tr> </table>	N.C.	1	Pt100 11	2	Pt100 12	3	Frame ground	Grounding lug		
N.C.		1											
Pt100 11	2												
Pt100 12	3												
Frame ground	Grounding lug												
4 ... 20 mA, 2-wire		<table border="1"> <tr><td>+Vs</td><td>1</td></tr> <tr><td>Iout</td><td>2</td></tr> <tr><td>N.C.</td><td>3</td></tr> <tr><td>Frame ground</td><td>Grounding lug</td></tr> </table>	+Vs	1	Iout	2	N.C.	3	Frame ground	Grounding lug			
+Vs	1												
Iout	2												
N.C.	3												
Frame ground	Grounding lug												

Ordering information

Ordering key - Configuration possibilities see website

Product	TE2	-	#	.	#	.	#	#	#	#	.	####	.	#	
Sensor tip	TE2														
Not specified												0			
Standard response tip, Ø 6 mm												1			
Fast response tip, Ø 4 mm												2			
Fast response tip, Ø 3 mm												3			

TE2

Compact RTD temperature sensor

TE2-#.###.###.0

Ordering information

Ordering key - Configuration possibilities see website

	TE2	-	#	.	#	.	#	#	#	#	.	####	.	#	
Process Connection															
Tube without connection (T65)															1
G 1/2 A ISO 228-1 (G06)															3
G 1/2 A hygienic (A03)															4
M12 × 1.5 hygienic (A02)															5
M12 × 1.5 hygienic, PEEK cone, sensor tip Ø 3x5 mm (A02)															6
G1/8 ISO 228/1 female thread, Hygienic (A01)															7
G 1/4 A DIN 3852-E, with NBR seal (G50)															8
ISO 2852 (Tri-Clamp), DN 25; 33.7; 38, Ø 50.5 (C04)															9
DIN 32676-C (Tri-Clamp), DN 3/4, Ø 25.0 (C01)															A
BHC 3A DN 38 (B01)															B
1/2-14 NPT (N02)															D
1/4-18 NPT (N01)															E
G 1/2 A DIN 3852-E, with FKM seal (G51)															F
G 1/2 A DIN 3852-E, with EPDM seal (G51)															G
Sensor element															
1/1 B EN 60751, single															1
1/1 B EN 60751, duplex															2
1/3 B EN 60751, single															3
1/3 B EN 60751, duplex															4
1/6 B EN 60751, single															5
1/6 B EN 60751, duplex															6
1/1 A EN 60751, single															7
1/1 A EN 60751, duplex															8
Cooling neck															
Without cooling neck															0
With cooling neck															4
Electrical connection															
M12-A, 4-pin, stainless steel															1
M12-A, 4-pin, stainless steel, with integrated transmitter															2
DIN EN 175301-803 A (DIN 43650 A), 4-pin ⁽¹⁾															4
DIN EN 175301-803 A (DIN 43650 A), 4-pin, with integrated transmitter ⁽¹⁾															5
M12-A, 4-pin, stainless steel, with integrated transmitter, out pin 2+3															A
Certificates															
Not specified															0
Railway EN 50155															4
Ex ia Simple apparatus, gas and dust															9
Sensor tube length (mm)															
5 - 3000															####
Configuration															
No configuration															0
Configuring according to customer specification															C

(1) Including female power connector