



Device Information

Model Name	VCXG-241C
Vendor Name	Baumer

Sensor Information

Sensor Name	Sony IMX540 Gen4
Type	1.2" progressive scan CMOS
Shutter	Global Shutter
Resolution	5312 x 4592 pixels
Scan Area	14.55 mm x 12.58 mm
Pixel Size	2.74 μm x 2.74 μm

Data Quality

@ 20 °C, gain = 1, exposure time = 4 msec

Dark Noise (σ)	2.3 e- typical
Saturation	9000 e- typical
Dynamic Range	70 dB typical
SNR	40 dB typical
Quantum efficiency η	45% @ 465 nm, 52% @ 536 nm, 41% @ 631 nm typical

Acquisition

Resolution	5312 px x 4592 px		
Interface Frame Rate (depends on used interface performance)	Format	Resolution	max. Frame Rate (@ Trigger Mode) ²⁾
	Full Frame	5312 x 4592	5 fps
	Binning 2x2	2656 x 2296	5 fps
	Binning 2x1	2656 x 4592	5 fps
	Binning 1x2	5312 x 2296	5 fps
Acquisition Frame Rate ¹⁾ (Burst Mode)	5 fps $t_{\text{readout}} = 174$ msec (max. Res. Full Frame) @ 10 bit		
	5 fps $t_{\text{readout}} = 174$ msec (max. Res. Full Frame) @ 12 bit		

Pixel Formats	BayerRG8, BayerRG10, BayerRG12, BayerRG12p Mono8, Mono10, Mono12, Mono12p, RGB8, BGR8
---------------	--

Partial Scan	True Partial Scan with increasing Frame Rate on Y direction, Region of Interest (ROI) arbitrary Width: minimum 16, increment 16 Height: minimum 2, increment 2
--------------	--

Adjustable Acquisition Frame Rate	Off or 0.01 ... 65535 Hz
Acquisition Mode	Continuous, Single Frame and Multi Frame
Acquisition Status	AcquisitionActive, AcquisitionTrigger Wait
Exposure Mode	Timed
Readout Mode	Overlapped, Sequential

Image Pre-Processing

Analog Controls	Exposure Time (1 μsec ... 60 sec Step Size 1 μsec) Gain (0...48 dB), Offset (0 ... 255 LSB 12 bit)
Auto Function	ExposureAuto and GainAuto with BrightnessAutoPriority based on BrightnessAuto ROI BalanceWhiteAuto and ColorTransformationAuto based on BalanceWhiteAuto ROI
LUT	Luminance (12 bit)
Color Models	Mono, Raw Bayer, RGB and BGR
Color Processing	Integrated color processor for high quality color calculation
Color Adjustment	Manual White Balance Automatic White Balance (Once or Continuous) based on Region of Interest (ROI)

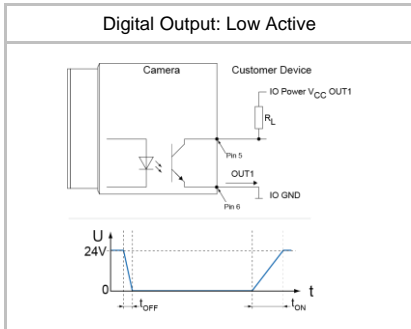
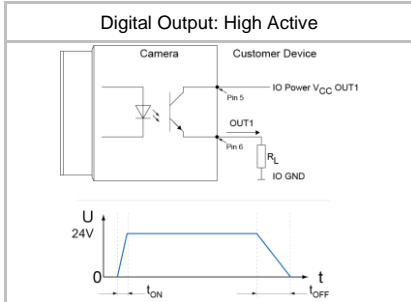
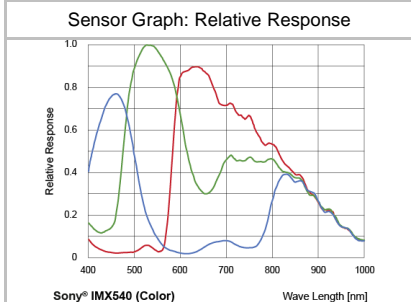

¹⁾ Sensor readout, different from pixel format

²⁾ depends on the used interface

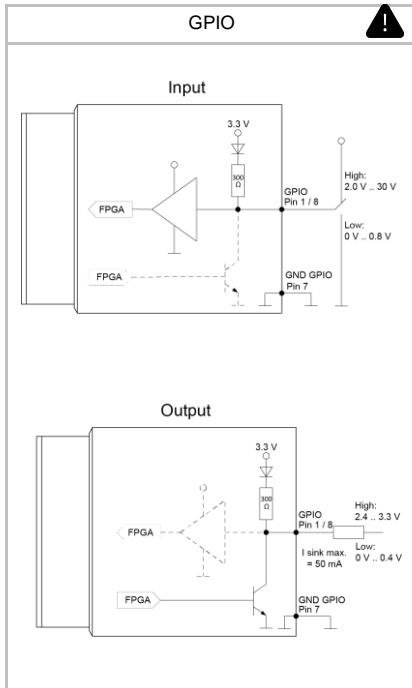
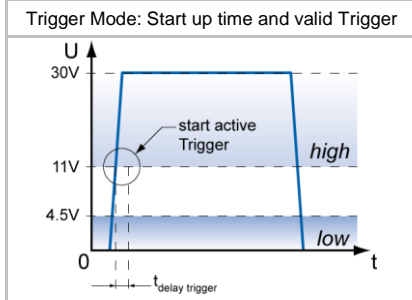
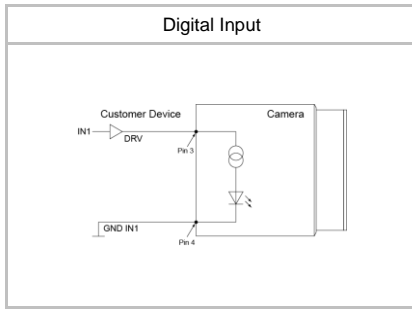

Image Pre-Processing

Color Enhancement	Color Transformation to sRGB color space by optimized Matrix for 3000 K, 5000 K, 6500 K and 9500 K Lightsource or User defined Matrix
Color Tolerance	-
Binning Horizontal	1 or 2
Binning Vertical	1 or 2
Defect Pixel Correction	via Defect Pixel List with up to 512 Pixel Coordinates
Image Flipping	Horizontal, vertical
Fix Pattern Noise Correction	-

Process Synchronization

Trigger Mode	Off (Free Running), On (Trigger)
Trigger Overlap Type	Readout
Trigger Sources	Hardware (Line0, 1, 2), Software, Counter 1, 2 End, Action CMD (Action 1), All or Off fixed Trigger Delay out of t _{readout} : ¹⁾ 315 µsec @ 12 bit max. Trigger Delay during t _{readout} : ¹⁾ 315 µsec @ 12 bit
Trigger Delay	0 ... 2 sec, Tracking and buffering of up to 256 triggers
External Flash Sync	via Exposure Active t _{delay flash} ≤ 3 µsec, t _{duration} = t _{exposure}
Encoder Function	yes, via Counter and Trigger Source
PTP Function	-

Digital I/Os

Lines	Input: Line 0, Output: Line3, GPIO: Line 1, Line 2
Line Sources (Output)	Off, ExposureActive, Timer1, ReadoutActive, UserOutput 1-3 and TriggerReady
Line Debouncer (Input)	Low and high signal separately selectable Debouncing Time 0 ... 5 msec, Step Size: 1 µsec

Memory

Image Buffer	140 MB 2 Images (Trigger Mode) / 1 Image (Free Running Mode)
Non-volatile Memory	128 kb

Network Interface Data

Interface	Gigabit Ethernet 1000BASE-T 1000 Mb/s/sec Fast Ethernet 100 BASE-T 100 Mb/s/sec
Ethernet IP Configuration	Persistent IP, DHCP, LLA
Packet Size	576 ... 9000 Byte, Jumbo Frames supported

GigE Vision® Features

Events Transmission via Asynchronous Message Channel	DeviceTemperatureStatusChanged, EventLost, ExposureEnd, ExposureStart, FrameEnd, FrameStart, FrameTransferSkipped, GigE VisionError, GigE VisionHeartbeatTimeOut, PrimaryApplicationSwitch, Line0..2 FallingEdge, Line0..2 RisingEdge, TransferBufferFull, TransferBufferReady, TriggerOverlapped, TriggerReady, TriggerSkipped
Action CMD	yes, Action 1 for Trigger
Frame Counter	up to 2 ³²
Payload Size	0 ... 73178336 Byte
Timestamp	64 bit, resolution in nsec, increment = 8
Packet Delay	0 ... 2 ³² - 1 nsec
Packet Resend	Resend Buffer: 140 MB (2 Images)
GigE Vision	v2.0

¹⁾ Sensor readout, different from pixel format

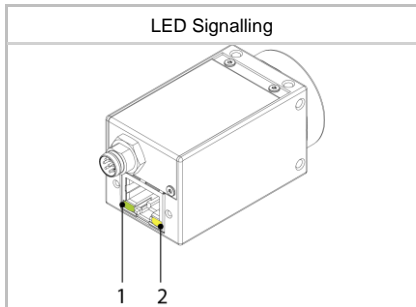
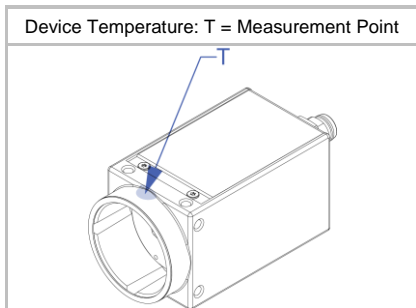
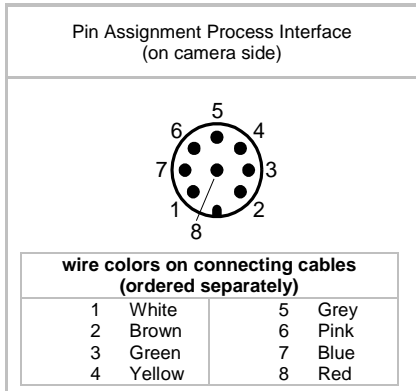
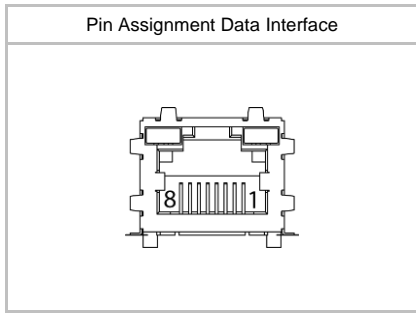

Interfaces and Connectors

Data and Power Interface	Gigabit Ethernet	Transfer Rate	1000 Mbits/sec
	Fast Ethernet	Transfer Rate	100 Mbits/sec
	Connector:	8P8C Modular Jack (RJ45), screw lock type	
Process Interface	Connector:	M8/8-pin (SACC-DSI-M8MS-8CON-M8-L180)	
	Assignment:	1 - MX1+	2 - MX1-
		3 - MX2+	4 - MX3+
		5 - MX3-	6 - MX2-
		7 - MX4+	8 - MX4-
		Assignment:	1 - GPIO (Line2)
		3 - IN1 (Line0)	4 - GND IN1
		5 - Power VCC OUT	6 - OUT1 (Line3)
		7 - GND (Power, GPIO)	8 - GPIO (Line1)

Caution



* Note GPIOs: Ground loops are to be avoided and can lead to destruction of the device.

Optical Data

Lens Mount	C-Mount
Optical Filter	IR cut filter

Mechanical Data

Housing	Zinc die casting, baked varnish
Protection Class	IP40 (with mounted lens and GigE cable)
Weight	120 g

Dimensions

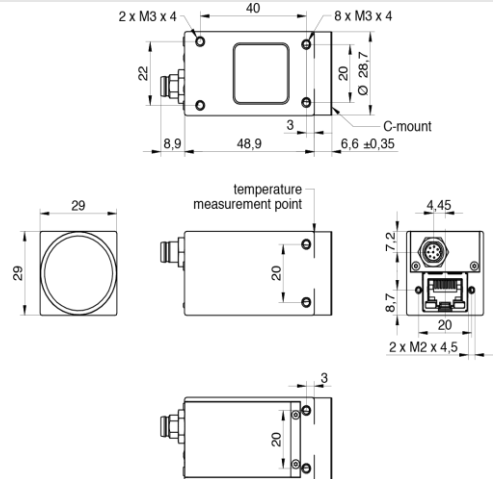

Additional Cooling Pipe	nono
-------------------------	------

Environmental Data

Storage Temperature	-10 °C ... +70 °C
Operating Temperature	0 °C ... +65 °C @ T = Measurement Point or 0 °C ... +75 °C @ internal Temperature Sensor
	Note: Ambient temperature above 30 °C requires heat dissipation measures.
Int. Temperature Sensor	yes, accuracy: ±2 °C (typ) -40 °C ... 0 °C ±1 °C (typ) 0 °C ... +85 °C
Humidity	10 % ... 90 % non-condensing

¹⁾ the maximum temperature for Sony sensor characteristics (sensor performance) are guaranteed up to 50 °C @ Measurement Point or up to 60 °C @ internal temperature sensor

LED Signalling

LED	LED 1	Green static	Link ON
		Green flash	RX active
	LED 2	Yellow static	Error
		Yellow flash	TX active

Electrical Data

Power Supply (ext.)	VCC: 12 ... 24 V DC \pm 20% I: 120 ... 242 mA
Power over Ethernet	Class 1 device VCC: 36 ... 57 V DC I: 73 mA @ 48 VDC
Power Consumption	approx. 2.9 W @ 12VDC and 5 fps approx. 3.5 W @ 48 VDC (PoE) and 5 fps (Factory Setting "Default")
Digital Input	Optocoupler $U_{IN(low)}$: 0.0 ... 4.5 VDC $U_{IN(high)}$: 11.0 ... 30.0 VDC I_{IN} : 3.0 ... 10.0 mA min. Impulse Length: 2.0 μ sec
Digital Output	Optocoupler U_{EXT} : 5 ... 30 V DC I_{OUT} : max. 50 mA t_{ON} = typ. 3 μ sec t_{OFF} = typ. 40 μ sec
GPIO	direct, without optocoupler
GPIO used as Input:	$U_{IN(low)}$: 0.0 ... 0.8 VDC $U_{IN(high)}$: 2.0 ... 30.0 VDC min. Impulse Length: 2.0 μ sec
GPIO used as Output:	$U_{Out(low)}$: 0.0 ... 0.4 VDC ($I_{sink\ max}$: 50 mA) $U_{Out(high)}$: 2.4 ... 3.3VDC (I_{max} : 1 mA)
Caution 	* The General Purpose I/Os (GPIOs) are not potential-free and do not have an overrun cut-off. Incorrect wiring (overvoltage, undervoltage or voltage reversal) can lead to defects in the electronic system. Ground loops are to be avoided and can lead to destruction of the device.

Conformity

Conformity	CE, RoHS, REACH
KC Registration No. / Date	- / -
MTBF	53 years @ T = 45 °C / 34 years @ T = 60 °C T = Measurement Point

GenICam™ Features

Short Exposure Range	yes, ShortExposureTimeEnable Short Exposure Range 1 ... 3 μ sec - 39 μ sec ... 60 sec Default Exposure Range 39 μ sec ... 60 sec
Timer	Timer Selector: Timer 1 TimerTriggerSource: Line0, SoftwareTrigger, ExposureStart, ExposureEnd, FrameTransferSkipped, TriggerSkipped, Action 1 and Off TimerDelay: 0 μ sec ... 2 sec, Step Size: 1 μ sec TimerDuration: 4 μ sec ... 2 sec, Step Size: 1 μ sec
Counter	Counter Selector: Counter 1, Counter 2 CounterValue: 0 ... 65535 Counter Event Source: Counter1End or Counter2End, ExposureActive, FrameTransferSkipped, FrameTrigger, TriggerSkipped, Line0..2 and Off Counter Reset Source: Counter1End, Counter2End, Line0..2 and Off

GenICam™ Features

Sequencer	Sequencer Characteristics: up to 128 sets, up to 4 possible pathes for triggered set transitions, 6 trigger sources: Counter1End, Counter2End, ExposureActive, Line0..2, ReadoutActive, Timer1End Sequencer Parameters for Exposure, Gain, Trigger, ROI and Output: ExposureTime, CounterDuration, CounterEventActivation, CounterEventSource, CounterResetSource, ExposureMode, ExposureTime, Gain, Height, OffsetX, OffsetY, TriggerMode, UserOutputValue, UserOutputValueAll, Width
User Sets	Factory Settings: UserSet0 (read only) Freely Programmable: UserSet1, UserSet2, UserSet3 Parameters: any user definable Parameter
Acquisition Abort	Delay up to 174 msec
Chunk Data	yes, Chunk Selector: Binning, BlackLevel, CounterValue, DeviceTemperature, ExposureTime, FrameID, Gain, Height, Image, ImageControl, LineStatusAll, OffsetX, OffsetY, PixelFormat, SequencerSetActive, Timestamp, Width
Device Temperature	InHouse Event generation for Normal to High, High to Exceeded and Exceeded to Normal Exceeded (no image transfer) = max. internal temperature sensor + 1 °C
Device Link Throughput Limit	yes, up to max. Device Link Speed
Custom Data	yes, 128 Byte with CustomDataKonfiguration Mode
SFNC Version	v2.4

Factory Settings after Start-Up

Ethernet IP Configuration	DHCP, LLA
Trigger Mode	Off (Free Running)
Analog Controls	Exposure Time: 4 msec, Gain: 0 dB, Offset: 0
Pixel Format	BayerRG8
Partial Scan	Off
Acquisition Frame Rate	Off
Timer/Counter/Sequencer	Off
Defect Pixel Correction	ON
Fixed Pattern Noise Correction	-
Digital Input	Line0, invert = false
Digital Output	Line3, invert = false, line source = Off
GPIO 1/2	Line1, Line2, invert = false, LineMode = Input
TriggerSource	All

Partial Scan @ FullFrame, min Exposure, Mono8 (monochrome camera) or BayerRG8 (color camera)

	Resolution	max. fps acquisition	max. fps interface ²⁾
HXGA	4096 x 3072	8	8
UHD (4K)	3840 x 2160	11	11
Full HD	1920 x 1080	22	22
SXGA	1280 x 1024	23	23
HD720	1280 x 720	32	32
XGA	1024 x 768	30	30
SVGA	800 x 600	37	37
VGA	640 x 480	45	45
CIF	352 x 288	67	67
QVGA	320 x 240	76	76
QCIF	176 x 144	105	105
LineScan	5312 x 4096	6	5
	5312 x 2048	12	11
	5312 x 1024	23	22
	5312 x 512	43	43
	5312 x 256	73	73
	5312 x 128	112	112
	5312 x 64	152	152
	5312 x 32	185	185
	5312 x 16	208	208
	5312 x 8	222	222
	5312 x 4	222	222
	5312 x 2	222	222
	5312 x 1	-	-

²⁾ depends on the used interface