

IWRM 12U9704/S14

Inductive distance sensors

Article number: 10145778

Overview

- 0 ... 4 mm
- voltage output
- connector M12
- -10 ... 70 °C
- IP 67



Picture similar



Technical data

General data

Mounting type	Quasi-flush
Measuring distance Sd	0 ... 4 mm
Resolution	< 0.001 mm (stat.) < 0.005 mm (dynam.)
Repeat accuracy	0.01 mm
Linearity error	± 160 µm
Temperature drift	± 4 % (Full Scale)

Electrical data

Response time (factory characteristic)	< 2 ms
Voltage supply range +Vs	15 ... 30 VDC
Current consumption max. (no load)	20 mA
Output circuit	Analog 0 ... 10 VDC

Electrical data

Load resistance	> 1000 Ohm
Short circuit protection	Yes
Reverse polarity protection	Yes

Mechanical data

Design	Cylindrical threaded
Material (sensing face)	PBT
Housing material	Brass nickel plated
Dimension	12 mm
Housing length	50 mm
Connection types	Connector M12
Tightening torque max.	15 Nm (Front: 10 Nm)

Ambient conditions

Operating temperature	-10 ... +70 °C
Protection class	IP 67

Remarks

- Linearity deviation (S = 0,5...4 mm) ± 4% (Full Scale)

IWRM 12U9704/S14

Dimension drawing

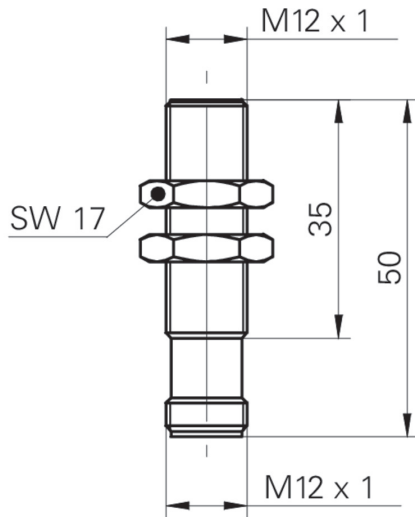

Installation drawing

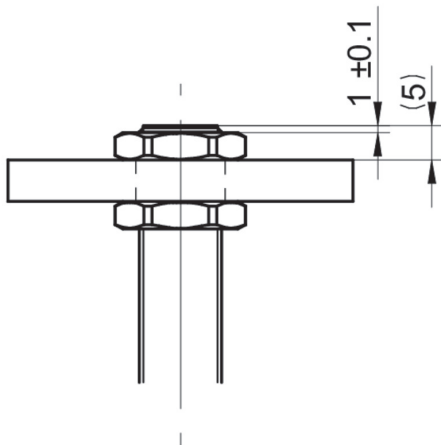

Connection diagram

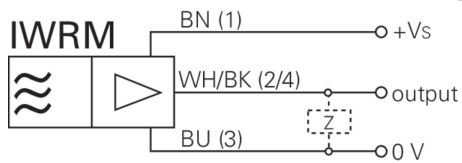

IWRM 12U9704/S14

Inductive distance sensors

Article number: 10145778

Accessories**Mounting accessories**

10151720	Sensofix series 12 round
11707685	Mounting rod with mounting plate holder 200 mm
11707686	Mounting rod with mounting plate holder 300 mm
11707688	Mounting rod 200 mm
11707697	Mounting rod 250 mm
11707698	Mounting rod with mounting plate holder 250 mm
11707687	Mounting rod 300 mm
11707701	Mounting plate series 300 and \varnothing 12 mm
11707702	Mounting base
11707703	Two-way connector