

## IWFM 18L9504/S35A

Inductive distance sensors - linearized

Article number: 10147042

### Overview

- 0 ... 4 mm
- voltage - / current output
- connector M8
- -10 ... 70 °C
- IP 67



Picture similar



### Technical data

#### General data

Mounting type	Flush
Measuring distance Sd	0 ... 4 mm
Resolution	< 0.005 mm
Repeat accuracy	0.01 mm
Linearity error	± 160 µm
Temperature drift	± 4 % (Full Scale)

#### Electrical data

Response time (factory characteristic)	< 2 ms
Voltage supply range +Vs	15 ... 30 VDC
Current consumption max. (no load)	40 mA
Output circuit	Analog 0 ... 10 VDC Analog 4 ... 20 mA
Load resistance	> 1000 Ohm (Uout) / 330 ... 1000 Ohm (Iout)

#### Electrical data

Voltage drop Vd	<7.2 VDC (Iout)
Short circuit protection	Yes
Reverse polarity protection	Yes

#### Mechanical data

Design	Rectangular
Material (sensing face)	PBT
Housing material	Brass nickel plated
Dimension	18 mm
Housing length	30 mm
Connection types	Connector M8

#### Ambient conditions

Operating temperature	-10 ... +70 °C
Protection class	IP 67

# IWFM 18L9504/S35A

Inductive distance sensors - linearized

Article number: 10147042

## Dimension drawing

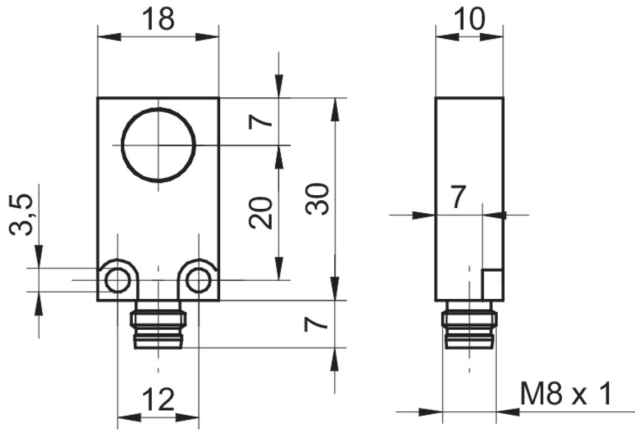

## Connection diagram

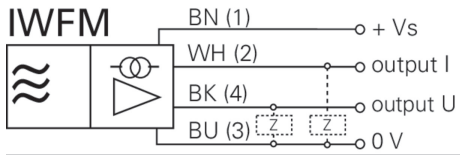

## Accessories

### Mounting accessories

10152385

10152385