

IWFM 12L9504/S35A

Inductive distance sensors

Article number: 10144961

Overview

- 0 ... 4 mm
- voltage - / current output
- connector M8
- -10 ... 70 °C
- IP 67



Picture similar



Technical data

General data

Mounting type	Flush
Measuring distance Sd	0 ... 4 mm
Resolution	< 0.005 mm
Repeat accuracy	0.01 mm
Linearity error	± 160 µm
Temperature drift	± 4 % (Full Scale)

Electrical data

Response time (factory characteristic)	< 2 ms
Voltage supply range +Vs	15 ... 30 VDC
Current consumption max. (no load)	40 mA
Output circuit	Analog 0 ... 10 VDC Analog 4 ... 20 mA
Load resistance	> 1000 Ohm (Uout) / 330 ... 1000 Ohm (Iout)

Electrical data

Voltage drop Vd	<7.2 VDC (Iout)
Short circuit protection	Yes
Reverse polarity protection	Yes

Mechanical data

Design	Rectangular
Material (sensing face)	PBT
Housing material	Brass nickel plated
Dimension	12 mm
Housing length	60 mm
Connection types	Connector M8

Ambient conditions

Operating temperature	-10 ... +70 °C
Protection class	IP 67

Remarks

- Linearity deviation (S = 0,5...4 mm) ± 4% (Full Scale)
- Load resistance: Uout min 1000 Ohm / Iout 330 - 1k
- Voltage drop Vd: Iout 7,2 V

IWFM 12L9504/S35A

Inductive distance sensors

Article number: 10144961

Dimension drawing

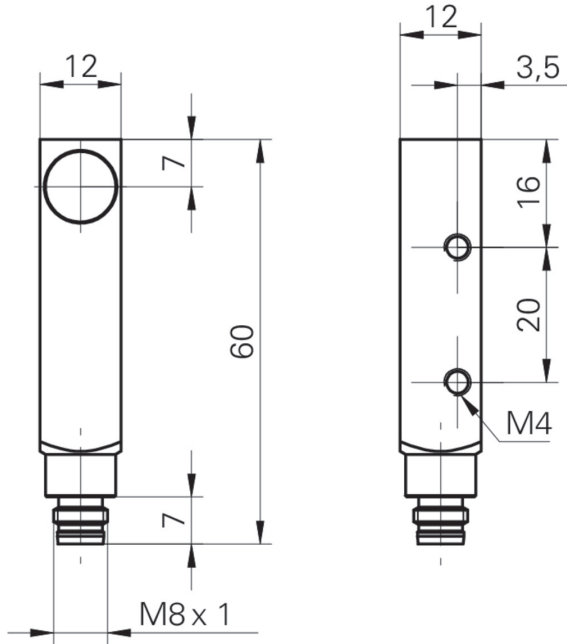

Connection diagram

