

## ITD69H02 - Sine signal

Through hollow shaft  $\varnothing 40$  to  $\varnothing 68$  mm

128 sinewave cycles per revolution

### Overview

- Bearingless magnetic encoder
- 128 sinewave cycles per revolution
- Output circuit: Sine 1 Vpp
- Fast, easy and space saving installation
- Maintenance-free
- High accuracy - error max.  $\pm 0.2^\circ$
- Rotation speed max. 6000 rpm
- High resistance to dirt and vibrations
- Magnetic rotor included in delivery



Picture similar

### Technical data

#### Technical data - electrical ratings

Voltage supply	5 VDC $\pm 10\%$
Reverse polarity protection	Yes
Short-circuit proof	Yes
Consumption w/o load	$\leq 50$ mA
Sinewave cycles per revolution	128
Output signals	A+, A-, B+, B- A+, A-, B+, B-, N+, N-
Output stages	SinCos 1 Vpp
Output frequency	$\leq 180$ kHz (-3 dB)
System accuracy	$\pm 0.2^\circ$
Interference immunity	EN 61000-6-2
Emitted interference	EN 61000-6-3
Approval	CE UL approval / E217823

#### Technical data - mechanical design

Shaft type	$\varnothing 40 \dots 68$ mm (through hollow shaft)
Dimensions (sensor head)	12 x 16 x 49 mm
Protection EN 60529	IP 67 (relating to sealed electronics)
Operating speed	$\leq 6000$ rpm
Working distance	0.2 ... 0.5 mm (radial), optimal 0,3 mm
Axial offset	$\pm 0.5$ mm
Material	Housing: plastic Shaft: stainless steel
Operating temperature	$-40 \dots +100$ °C (fixed cable)
Resistance	EN 60068-2-6 Vibration 10 g, 55-2000 Hz EN 60068-2-27 Shock 100 g, 11 ms
Weight approx.	390 g
Connection	Cable 1 m

### Optional

- Cable with connector
- Redundant sensing

# ITD69H02 - Sine signal

Through hollow shaft  $\varnothing 40$  to  $\varnothing 68$  mm

128 sinewave cycles per revolution

## Terminal assignment

### With BI-signals, cable [4x2x0,08 mm<sup>2</sup>]

Core colour	Assignment
green	A +
yellow	A -
grey	B +
pink	B -
red	UB
blue	GND
transparent	Shield/Housing

### With NI-signals, cable [4x2x0,08 mm<sup>2</sup>]

Core colour	Assignment
green	A +
yellow	A -
grey	B +
pink	B -
brown	N +
white	N -
red	UB
blue	GND
transparent	Shield/Housing

## Output signal level

Outputs	Sine
Output amplitude A + B	1 V <sub>PP</sub> at Z <sub>0</sub> = 120 Ω
Output amplitude N	approx. 2,5 V at Z <sub>0</sub> = 120 Ω

## Output signals

Clockwise rotation when looking at the mounting side.

### BI-Output signals

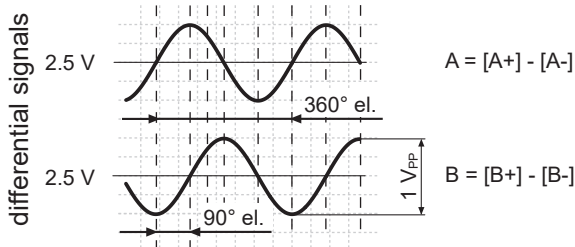

### NI-Output signals

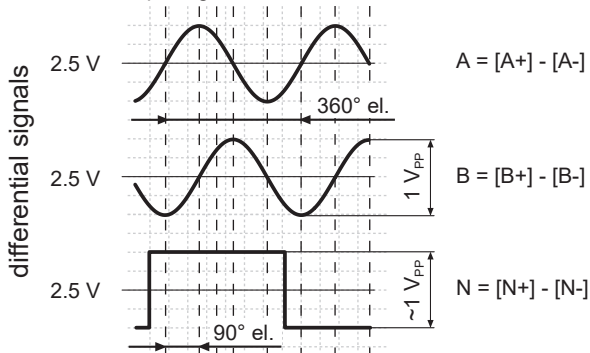

# ITD69H02 - Sine signal

Through hollow shaft  $\varnothing 40$  to  $\varnothing 68$  mm

128 sinewave cycles per revolution

## Dimensions

### mounting side (proposition)

### dimension drawing (optimal mounting)

d H6:  $\varnothing 60$ - $\varnothing 68$

d H6:  $\varnothing 40$ - $\varnothing 55$

3 set screws  
DIN EN ISO 4029 - M4  
A/F2  
tightening torque  
 $2.4 \pm 0.2$  Nm

3 set screws  
DIN EN ISO 4029 - M4  
A/F2  
tightening torque  
 $2.4 \pm 0.2$  Nm

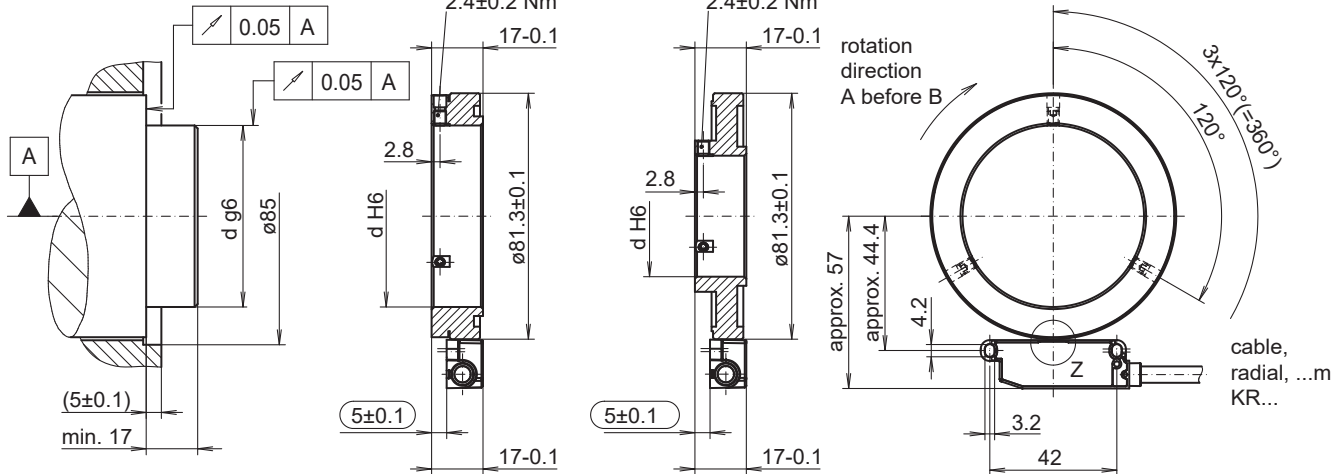

## Mounting tolerances, operating tolerances

Permitted change of position sensor to rotor during mounting and operation:

### Axial offset:

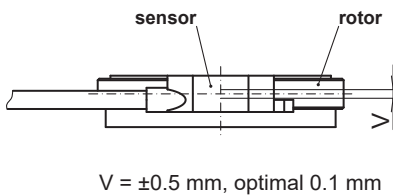

### Working distance:

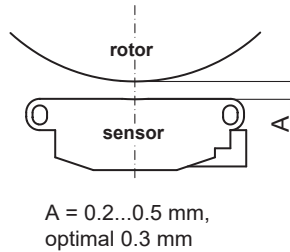

Use the distance band as a mounting tool for optimal gap (0.3 mm) between sensor and rotor.

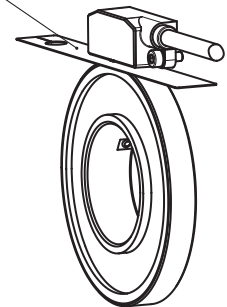

## Mounting position

Mounting position (1-1) sensor to rotor should not be altered!

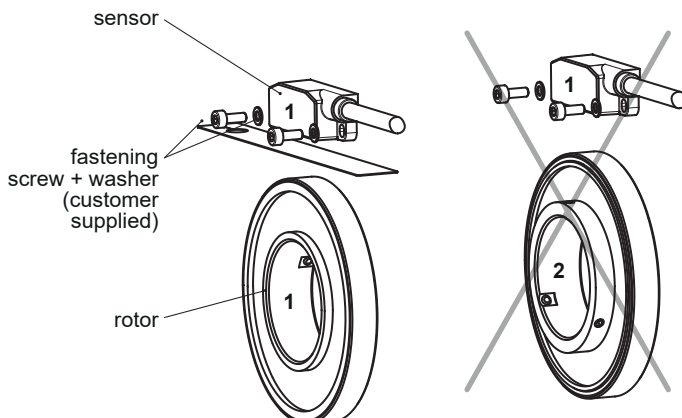

## ITD69H02 - Sine signal

Through hollow shaft  $\varnothing 40$  to  $\varnothing 68$  mm

128 sinewave cycles per revolution

### Ordering reference

	<b>ITD69H02</b>	<b>128</b>	<b>M</b>	<b>####</b>	<b>KR1</b>	<b>E</b>	<b>##</b>	<b>IP67</b>
<b>Product</b>	ITD69H02							
<b>Sinewave cycles</b>		128						
<b>Voltage supply / signals</b>			M					
<b>Output signals</b>								
A+, A-, B+, B- (sine)								BI
A+, A-, B+, B-, N+, N- (sine)								NI
<b>Connection</b>								
Cable 1 m, radial								KR1
<b>Operating temperature</b>								
-40...+100 °C								E
<b>Through hollow shaft</b>								
$\varnothing 40$ mm								40
$\varnothing 42$ mm								42
$\varnothing 45$ mm								45
$\varnothing 50$ mm								50
$\varnothing 55$ mm								55
$\varnothing 60$ mm								60
$\varnothing 65$ mm								65
$\varnothing 68$ mm								68
<b>Protection</b>								
IP 67								IP67

Other diameters on request