

ITD69H02 - Sine signal

Through hollow shaft $\varnothing 40$ to $\varnothing 68$ mm

128 sinewave cycles per revolution

Overview

- Bearingless magnetic encoder
- 128 sinewave cycles per revolution
- Output circuit: Sine 1 Vpp
- Fast, easy and space saving installation
- Maintenance-free
- High accuracy - error max. $\pm 0.2^\circ$
- Rotation speed max. 6000 rpm
- High resistance to dirt and vibrations
- Magnetic rotor included in delivery



Picture similar

Technical data

Technical data - electrical ratings

Voltage supply	5 VDC $\pm 10\%$
Reverse polarity protection	Yes
Short-circuit proof	Yes
Consumption w/o load	≤ 50 mA
Sinewave cycles per revolution	128
Output signals	A+, A-, B+, B- A+, A-, B+, B-, N+, N-
Output stages	SinCos 1 Vpp
Output frequency	≤ 180 kHz (-3 dB)
System accuracy	$\pm 0.2^\circ$
Interference immunity	EN 61000-6-2
Emitted interference	EN 61000-6-3

Technical data - mechanical design

Shaft type	$\varnothing 40 \dots 68$ mm (through hollow shaft)
Dimensions (sensor head)	12 x 16 x 49 mm
Protection EN 60529	IP 67 (relating to sealed electronics)
Operating speed	≤ 6000 rpm
Working distance	0.2 ... 0.5 mm (radial), optimal 0,3 mm
Axial offset	± 0.5 mm
Material	Housing: plastic Shaft: stainless steel
Operating temperature	$-40 \dots +100^\circ\text{C}$ (fixed cable)
Resistance	EN 60068-2-6 Vibration 10 g, 55-2000 Hz EN 60068-2-27 Shock 100 g, 11 ms
Weight approx.	390 g
Connection	Cable 1 m

Optional

- Cable with connector
- Redundant sensing

ITD69H02 - Sine signal

Through hollow shaft $\varnothing 40$ to $\varnothing 68$ mm

128 sinewave cycles per revolution

Terminal assignment

With BI-signals, cable [4x2x0,08 mm²]

Core colour	Assignment
green	A +
yellow	A -
grey	B +
pink	B -
red	UB
blue	GND
transparent	Shield/Housing

With NI-signals, cable [4x2x0,08 mm²]

Core colour	Assignment
green	A +
yellow	A -
grey	B +
pink	B -
brown	N +
white	N -
red	UB
blue	GND
transparent	Shield/Housing

Output signal level

Outputs	Sine
Output amplitude A + B	1 V _{PP} at Z ₀ = 120 Ω
Output amplitude N	approx. 2,5 V at Z ₀ = 120 Ω

Output signals

Clockwise rotation when looking at the mounting side.

BI-Output signals

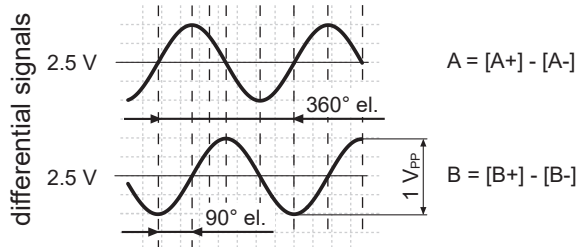

NI-Output signals

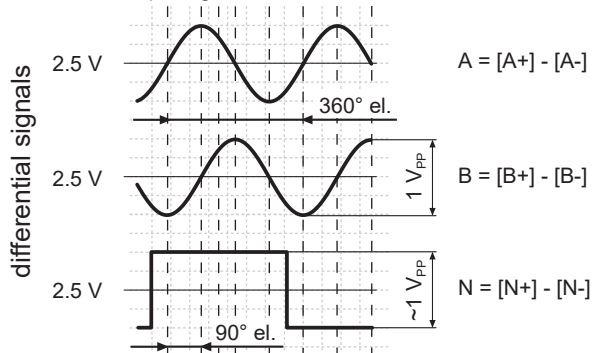

ITD69H02 - Sine signal

Through hollow shaft $\varnothing 40$ to $\varnothing 68$ mm

128 sinewave cycles per revolution

Dimensions

mounting side (proposition)

dimension drawing (optimal mounting)

d H6: $\varnothing 60$ - $\varnothing 68$

d H6: $\varnothing 40$ - $\varnothing 55$

3 set screws
DIN EN ISO 4029 - M4
A/F2
tightening torque
 2.4 ± 0.2 Nm

3 set screws
DIN EN ISO 4029 - M4
A/F2
tightening torque
 2.4 ± 0.2 Nm

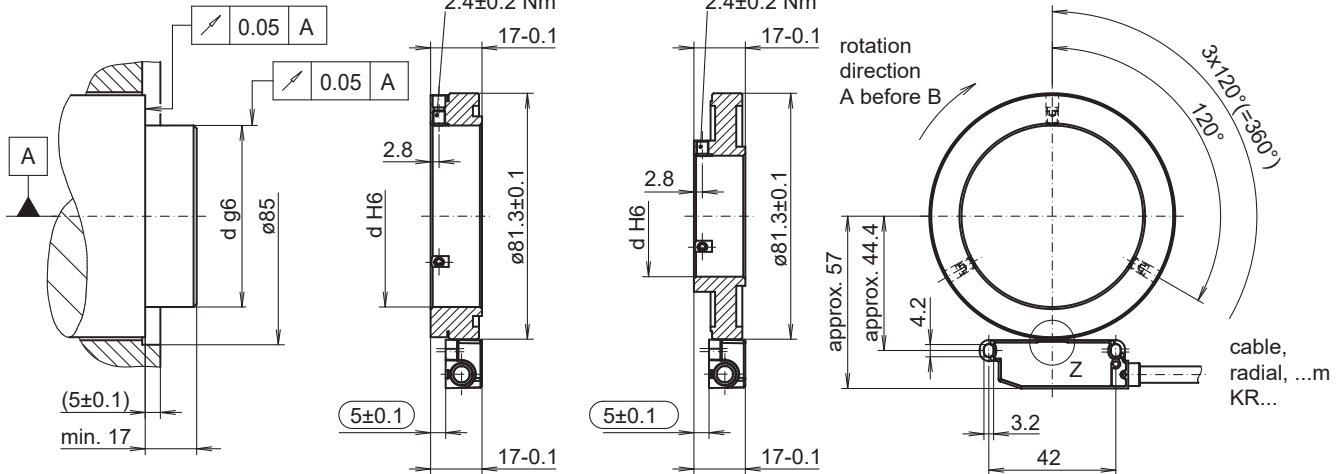

Mounting tolerances, operating tolerances

Permitted change of position sensor to rotor during mounting and operation:

Axial offset:

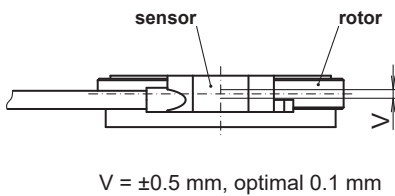

Working distance:

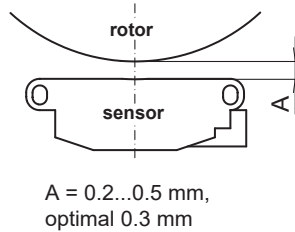

Use the distance band as a mounting tool for optimal gap (0.3 mm) between sensor and rotor.

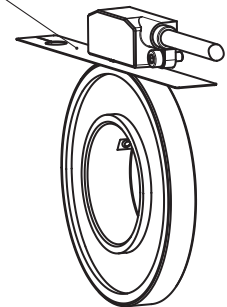

Mounting position

Mounting position (1-1) sensor to rotor should not be altered!

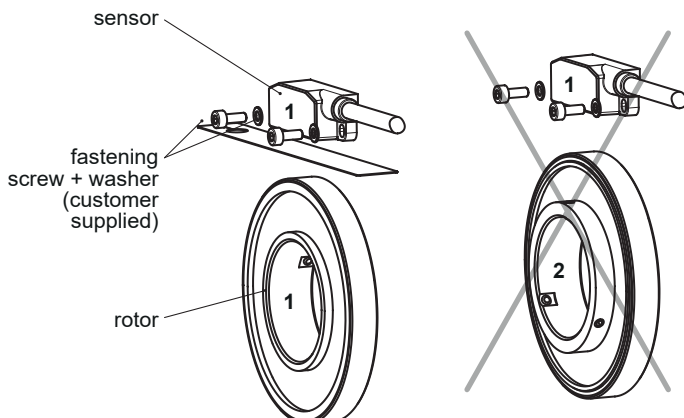

ITD69H02 - Sine signal

 Through hollow shaft $\varnothing 40$ to $\varnothing 68$ mm

128 sinewave cycles per revolution

Ordering reference

	ITD69H02	128	M	####	KR1	E	##	IP67
Product	ITD69H02							
Sinewave cycles	128	128						
Voltage supply / signals	5 VDC / sine 1 Vpp		M					
Output signals	A+, A-, B+, B- (sine)			BI				
	A+, A-, B+, B-, N+, N- (sine)			NI				
Connection	Cable 1 m, radial				KR1			
Operating temperature	-40...+100 °C					E		
Through hollow shaft								
	$\varnothing 40$ mm							40
	$\varnothing 42$ mm							42
	$\varnothing 45$ mm							45
	$\varnothing 50$ mm							50
	$\varnothing 55$ mm							55
	$\varnothing 60$ mm							60
	$\varnothing 65$ mm							65
	$\varnothing 68$ mm							68
Protection	IP 67							IP67

Other diameters on request