

Overview

- Through-beam type
- Actual range up to 450 mm
- Cylindrical smooth sensing head $\varnothing 4$ mm, side view
- Metal jacket 50 cm long
- Operating temperature up to +120 °C
- For rugged fiber optic sensors FZAM 18 and FZAM 30



Picture similar

Technical data

General data

Particular characteristics	Smooth sensing head Side view
Operating principle	Through-beam type
Actual range Sb	450 mm
Fiber optic head	Cylindrical smooth, side view
Operating temperature	-25 ... +120 °C
Exit angle	60°
Fiber optics can be shortened to length	No
Integrated lens	No
Adaptable lens	No
Infrared light compatibility (1450 nm)	Yes

Mechanical data

Width / diameter (head)	4 mm
Height / length (head)	16 mm
Material (head)	Aluminum
Bending radius (fixed)	15 mm
Bending radius (mobile)	24 mm
Cable jacket diameter	4 mm
Material cable jacket	Brass chromium plated
Fiber cross section	1 mm ²
Material (fiber optic cable)	Glass
Length (fiber optic cable)	50 cm

Dimension drawing

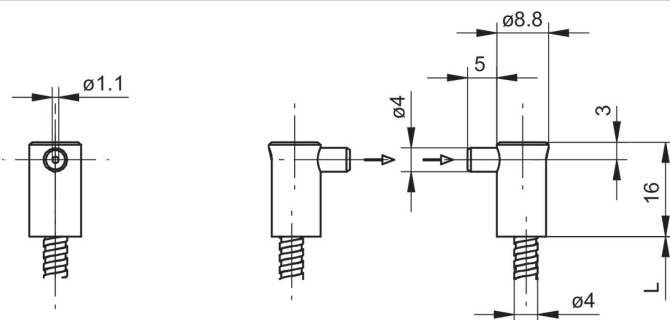

Actual range diagram

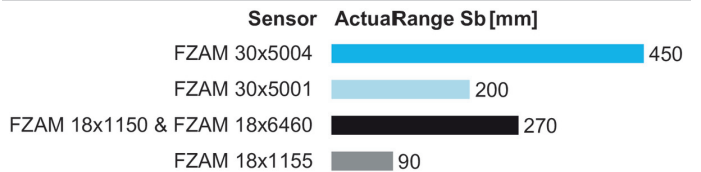

Fiber arrangement

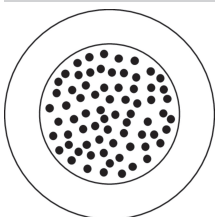

Accessories

Fitting fiber optic sensors

10129020	FZAM 18N1150
10129021	FZAM 18N1150/S14
10129023	FZAM 18N1155
10128874	FZAM 18N6460
10128875	FZAM 18N6460/S14
10127712	FZAM 18P1150
10128111	FZAM 18P1150/S14
10127711	FZAM 18P1155
10128118	FZAM 18P6460
10127710	FZAM 18P6460/S14
10215060	FZAM 30N5004
10214166	FZAM 30P5001
10215057	FZAM 30P5004

Mounting accessories

10106042	Adapter series 30 for angeled fiber optics
10101958	Adjusting plate series 18
10101480	Replacements cap nut for fiber optics series 18
10102801	Cap nut for sensors series 30