

FSF 025B1005

Glass fiber optic cable

Article number: 10217053

Overview

- Through-beam type
- Actual range up to 140 mm
- Threaded sensing head M3
- Metal jacket 25 cm long
- Operating temperature up to +250 °C
- For rugged fiber optic sensors FVDM 15



Picture similar

Technical data

General data

Operating principle	Through-beam type
Actual range Sb	140 mm
Fiber optic head	Cylindrical threaded
Operating temperature	-25 ... +250 °C
Exit angle	60°
Fiber optics can be shortened to length	No
Integrated lens	No
Adaptable lens	Yes
Infrared light compatibility (1450 nm)	Yes

Mechanical data

Width / diameter (head)	3 mm
Height / length (head)	17 mm
Material (head)	Brass
Thread	M3 x 0.5
Bending radius (fixed)	15 mm
Bending radius (mobile)	24 mm
Cable jacket diameter	4 mm
Material cable jacket	Brass chromium plated
Fiber cross section	1 mm ²
Material (fiber optic cable)	Glass
Length (fiber optic cable)	25 cm

Dimension drawing

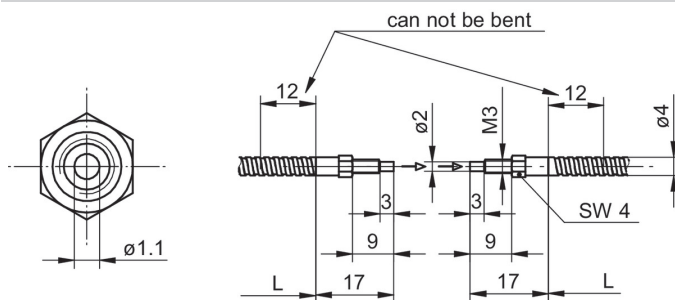

Fiber arrangement

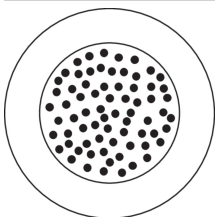

Accessories**Fitting fiber optic sensors**

10234639	FVDM 15N5103
10122368	FVDM 15N5103/S14
10234520	FVDM 15P5103
10239451	FVDM 15P5103/S14
10234519	FVDM 15P5130
10124952	FVDM 15P5130/S14

Mounting accessories

10103230	Replacement cap nut for fiber optics series 15
----------	--

Lenses and components

10119910	Doubling lens M3 increases the actual range (paires)
----------	--