

Vue d'ensemble

- M8, female, A-coded; 4-poles; TPE, 500 cm, free cable end
- Dragchain capable, suitable for robotics, suitable for food & beverage
- Head A: IP65, IP66K, IP67, IP69
- Cable: Good resistance against chemicals, flames and oils
- Halogen free

Caractéristiques techniques

Side A		Cable	
Head A: Connection	M8	Conductor: Material	Copper, bare
Head A: Angle cable outlet	0°	External sheath: Material	TPE
Head A: Gender	Female	Insulation: Material	TPE
Head A: Coding	A	No. of bending cycles (C-track)	≥ 4000000 Cycles
Head A: No. of poles	4	Nominal voltage	240 V
Head A: Tightening torque	0,6 Nm	Cable: Test voltage	2000 V 0
Head A: Knurled nut material	Stainless steel (V4A)	Travel speed (C-track)	≤ 3 m/s
Head A: Gasket material	EPDM	Traversing path (horizontal)	≤ 10 m
Side B		Wire cross section	0,34 mm ²
Head B: Connection	Open-ended wires	External sheath: Color	Gray
Cables		Données électriques	
Cable length	500 cm	Operating voltage	240 V
Stripping length	0 mm	Nominal voltage	240 V
Conductor structure	42 × 0,1 mm	Contact resistance	≤ 5 mOhm
AWG	22	Operating current per contact	max. 4 A
External sheath: Material	TPE	Données mécaniques	
External sheath: Color	Gray	Head A: Degree of protection	IP65, IP67, IP68, IP69
Cable diameter	4,6 mm ± 5%	Bending radius (mobile)	min. 10 × outer diameter
Wire cross section	0,34 mm ²	Bending radius (fixed)	min. 5 × outer diameter
Cable		No. of bending cycles (C-track)	≥ 4000000 Cycles
Cable: Temperature range (mobile)	- 40 ...+ 105 °C	Acceleration (C-track)	≤ 10 m/s ²
Cable: Temperature range (fixed)	- 25 ...+ 105 °C	Travel speed (C-track)	≤ 3 m/s
Bending radius (fixed)	23 mm	Conditions ambiantes	
Cable length	500 cm	Temperature range (mobile)	- 25 ...+ 105 °C
Acceleration (C-track)	≤ 10 m/s ²	Temperature range (fixed)	- 40 ...+ 105 °C
AWG	22	Cable: Temperature range (fixed)	- 25 ...+ 105 °C
Bending radius (fixed)	min. 5 × outer diameter	Dragchain capable	Oui
Bending radius (mobile)	min. 10 × outer diameter	Head A: Pollution degree	3
Conductor structure	42 × 0,1 mm	Cable: Chemical resistance	Good
Cable diameter	4,6 mm ± 5%		
Insulation resistance	≥ 1000000 Ohm		

Side A

Technical drawing



Schéma de raccordement



Coding

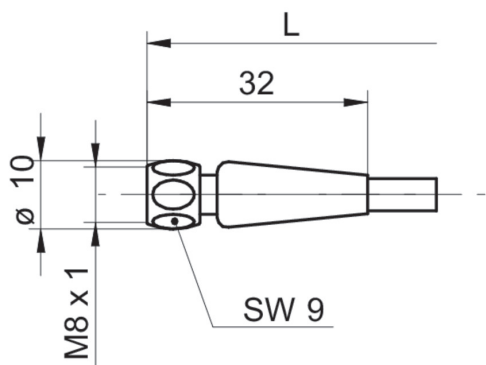
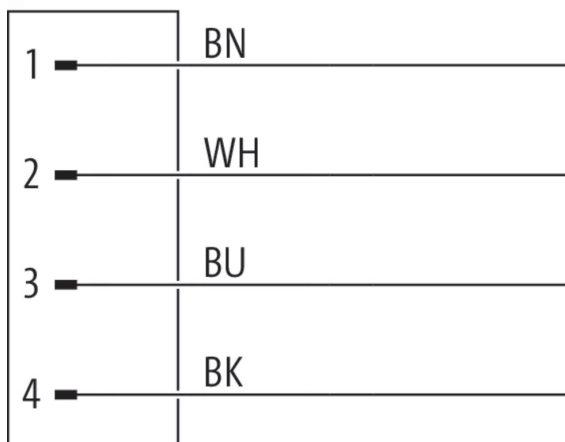