

EN580C.ML-BN14.GH2PB.21160.H

Blind hollow shaft, optical multiturn encoders up to 21 bit ST / 16 bit MT

Article number: 11268063

Overview

- Encoder multiturn / bus cover
- Optical sensing method
- Resolution: singleturn 21 bit (default: 13 bit), multiturn 16 bit (default: 16 bit)
- Total resolution up to 31 bit
- Blind hollow shaft
- Interface: Profibus-DPV0
- Internal continuity check with diagnostic information by bus
- Maximum resistant against magnetic fields
- Gear factor adjustable via numerator / denominator

Picture similar

Technical data

Technical data - electrical ratings

Voltage supply	8...30 VDC
Reverse polarity protection	Yes
Consumption w/o load	≤100 mA (24 VDC)
Initializing time typ.	180 ms after power on
Interface	Profibus-DPV0
Function	Multiturn
Device adress	Rotary switches in bus cover
Steps per revolution	≤2097152 / 21 bit
Number of revolutions	≤65536 / 16 bit
Absolute accuracy	±0.01 °
Sensing method	Optical
Code	Binary
Interference immunity	EN 61000-6-2
Emitted interference	EN 61000-6-3
Programmable parameters	Steps per revolution Number of revolutions Preset Scaling Rotating direction Gear factor
Diagnostic function	Position or parameter error Multiturn sensing Operating hour counter
Status indicator	DUO-LED integrated in bus cover
Approval	UL approval / E217823

Technical data - mechanical design

Size (flange)	ø58 mm
Shaft type	ø14 mm (blind hollow shaft)
Protection EN 60529	IP 54 (without shaft seal)
Operating speed	≤6000 rpm (+25 °C)
Starting acceleration	≤1000 U/s ²
Starting torque	≤0.02 Nm (+25 °C, IP 54)
Motor shaft tolerance	± 0.2 mm (axial offset) ≤ 0.1 mm (radial offset) ≤ 0.1 mm (concentricity)
Material	Housing: aluminium Flange: aluminium Bus cover: zinc die-cast Shaft: stainless steel
Operating temperature	-25...+85 °C (see general information)
Relative humidity	95 % non-condensing
Resistance	EN 60068-2-6 Vibration ±0.75 mm - 10-58 Hz, 10 g - 58-2000 Hz EN 60068-2-27 Shock 200 g, 3 ms
Weight approx.	550 g
Connection	Cable gland
Instruction	Resonance frequency with stator coupling (11721627): 450...600 Hz

General information

Self-heating correlated to installation and ambient conditions as well as to electronics and supply voltage must be considered for precise thermal dimensioning. Operating the encoder close to the maximum limits requires measuring the real prevailing temperature at the encoder flange.

Terminal assignment

Cable gland

+Vs	Voltage supply 8...30 VDC
0 V	Ground connection relating to +Vs
A	Negative data line
B	Positive data line

Terminals of the same significance are internally connected and identical in their functions. Max. load on the internal terminal connections Vs-Vs and 0V-0V is 1 A each.

View inside bus cover

Cable gland

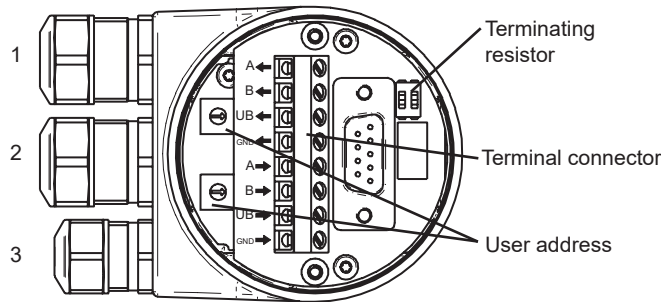

Cable: 1, 2 = \varnothing 8-10 mm (-40-85 °C) / \varnothing 5-9 mm (-25-85 °C)
Cable: 3 = \varnothing 4.5-6 mm (-40-85 °C) / \varnothing 3-6 mm (-25-85 °C)

Terminating resistor



Both ON = final user
Both OFF = user X
Default: OFF

User address

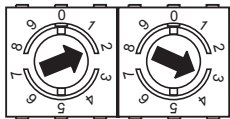

Defined by rotary switch.
Example: User address 23
Default: 00

Profibus-DP features

Bus protocol	Profibus-DPV0
Device profile	Device Class 1 and 2
Cyclic data exchange	Communication in line with DPV0
Input data	Position value. In addition optionally speed signal parametering.
Output data	Preset value
Preset	Parameter for setting the encoder to a requested position value assigned to a defined shaft position of the system. Storage non-volatile.
Rotating direction	Parameter for defining the rotating direction in which there have to be ascending or descending position values.
Scaling	Parameter defining the steps per turn as well as the total resolution.
Gear factor	Adjustable via numerator / denominator.
Diagnosis	Position and parameter error Multiturn sensing control Operating hour counter readable

EN580C.ML-BN14.GH2PB.21160.H

Blind hollow shaft, optical multiturn encoders up to 21 bit ST / 16 bit MT

Article number: 11268063

Dimensions

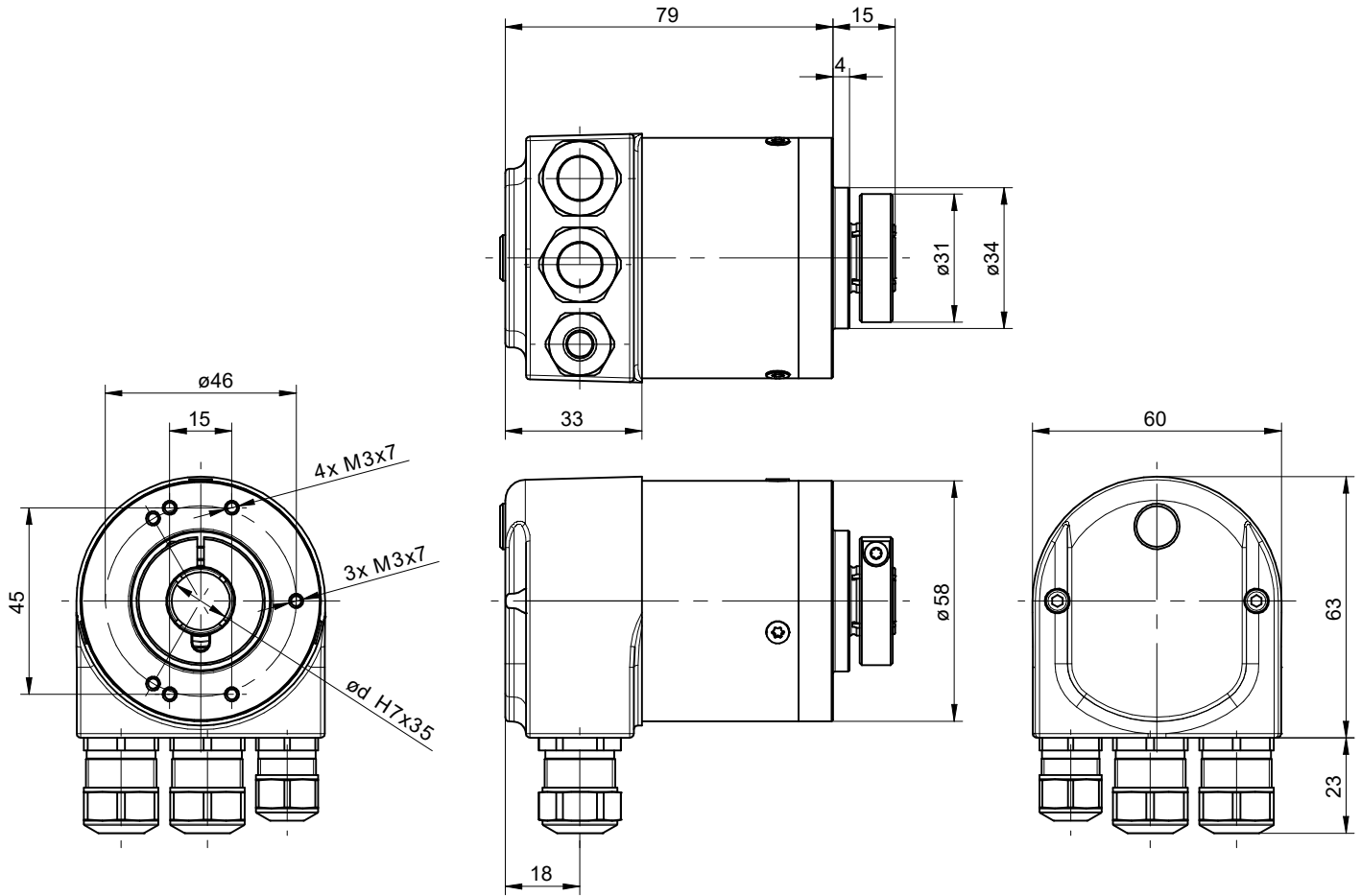

EN580C.ML-B - cable gland

EN580C.ML-BN14.GH2PB.21160.H

Blind hollow shaft, optical multiturn encoders up to 21 bit ST / 16 bit MT

Article number: 11268063

Accessories

Mounting accessories

11721627 Stator coupling, 2-armed (mounting kit 207)