

EB200E.IR-FN.8L2C5.008L

32...1024 pulses per revolution

Article number: 11705077

Overview

- Parameterizable incremental encoder (HTL)
- Simple position and speed detection via IO-Link
- Speed monitor function via switching output
- Bearingless magnetic sensing
- Maximum resolution 4096 steps per revolution
- Magnetic rotor not included in delivery



Picture similar

Technical data

Technical data - electrical ratings

Voltage supply	8...30 VDC
Reverse polarity protection	Yes, to 0 V
Short-circuit proof	Yes
Consumption w/o load	≤25 mA (24 VDC)
Initializing time typ.	150 ms after power on
Pulses per revolution	64 ... 1024 32 ... 512
Interface	IO-Link
Interpolation	8-fold (parameterizable up to 16-fold)
Output signals	A+ / IO-Link, B+
Output stages	HTL/push-pull IO-Link
Output frequency	≤160 kHz
System accuracy	Typ. ±0.5° (+20 °C, EBS.R-FN032/064)
Sensing method	Magnetic
Interference immunity	EN 61000-6-2
Emitted interference	EN 61000-6-3
Approval	CE UL approval / E217823

Technical data - electrical ratings (IO-Link)

IO-Link version	1.1
Device profile	Smart Sensor Profile 1.0 2nd Edition
IO-Link port type	Class A
Baud rate	38.4 kBaud (COM 2)
Cycle time	≥ 5 ms
Process data length	72 Bit
Process data structure	Bit 0 = SSC1 (speed monitor) Bit 1 = SSC2 (direction monitor) Bit 3 = alarm Bit 4 = SSC3 (standstill monitor) Bit 8-39 = 32 Bit Position Bit 40-71 = 32 Bit Speed

Technical data - electrical ratings (IO-Link)

Additional data	Device status Device temperature Operating time Revolutions count
Adjustable parameters	Interpolation Direction Poles per revolution Speed unit Speed filter Preset position Temperature alarm settings Switching point Switching mode Switching logic Switching hysteresis Output function Output logic Output startup settings

Technical data - mechanical design

Shaft type	ø8...48 mm (through hollow shaft)
Dimensions W x H x L	12 x 16 x 48 mm
Protection EN 60529	IP 65 IP 67
Operating speed	≤6000 rpm
Working distance	0.1 ... 1.0 mm (radial air gap) ± 1.0 mm (axial misalignment) ± 1.0 mm (tangential misalignment)
Material	Housing: polyamide Cable sheath: PVC black
Operating temperature	-40...+85 °C
Relative humidity	95 %
Resistance	EN 60068-2-6 Vibration 30 g, 10-2000 Hz EN 60068-2-27 Shock 500 g, 1 ms
Weight approx.	230 g
Connection	Cable 5 m
Admitted cable length	20 m

General information

EB200E.IR-FN sensors are compatible with EBS.R-FN magnetic rotors, which needs to be ordered separately. The number of pulses per revolution results from the number of poles of the magnetic rotor multiplied by the interpolation of the sensor (PPR = Number of poles x Interpolation).

Terminal assignment

Cable

Core colour	Assignment	Description
brown	+Vs	Voltage supply
white	B+	Output B
blue	0 V	Voltage supply
black	A+ / IO-Link	Output A / IO-Link

Cable data: PVC 4 x 0.25 mm², unshielded

Bending radius: >60 mm

Outer diameter: 5.8 mm

Output signals

Output A

Output A is IO-Link capable and the following functions are parametrizable (SIO): Encoder Channel A (default), Speed-, Standstill- or Direction Monitor:

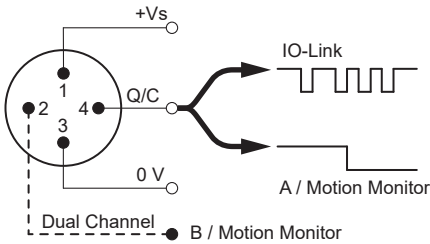

Output B

Parametrizable functions: Encoder Channel B (default), Speed-, Standstill- or Direction Monitor

Trigger level

Outputs	Push-pull short-circuit proof
Output level High	≥18.3 V (+Vs = 24 VDC)
Output level Low	≤5.3 V (+Vs = 24 VDC)
Load	≤30 mA

Angular misalignment

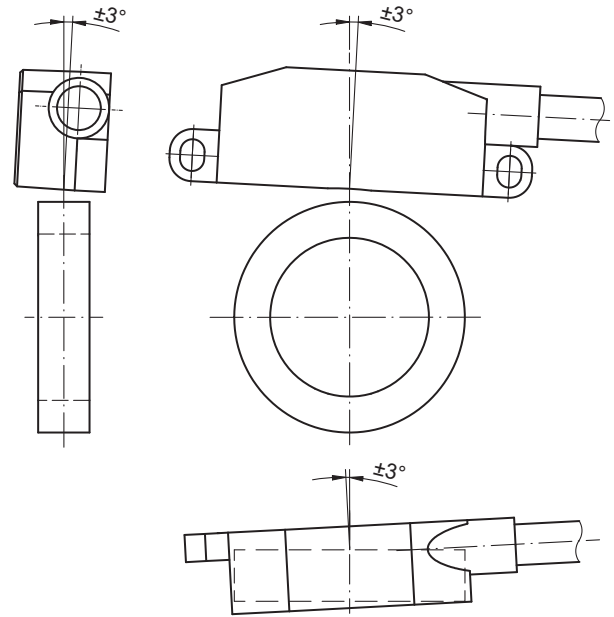

Working distance

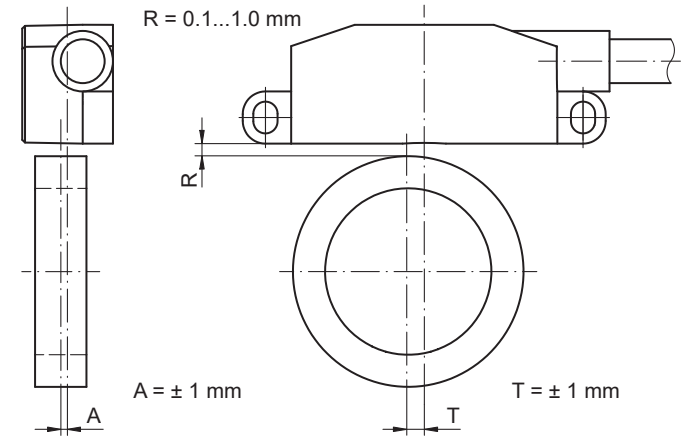

Output Functions

Output function: Incremental Encoder (HTL)

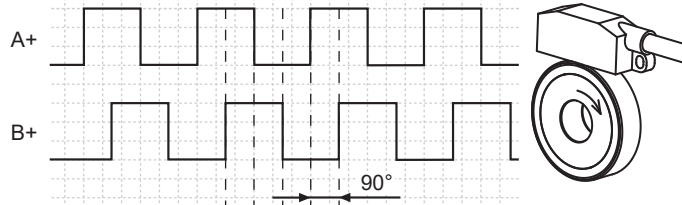

Channel A is leading B by 90° when rotating CW

Parameters:

- Interpolation
- Direction
- Output function
- For more details, please refer to the IODD.

Output function: Speed Monitor (SSC1)

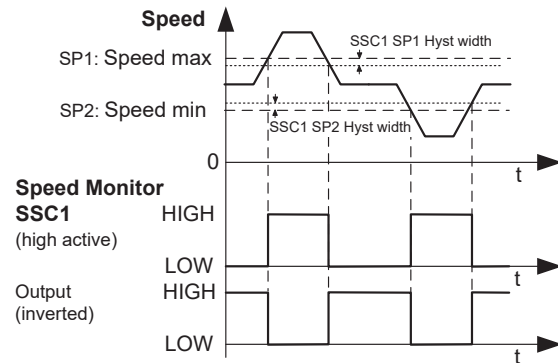

Parameters:

- Switching points (Speed limit max, Speed limit min)
- Switching logic (high active, low active)
- Switching mode (Speed limit, Speed Window)
- Switching hysteresis (Setpoint 1, Setpoint 2)
- Output function
- Output logic
- Output startup settings
- For more details, please refer to the IODD.

Output function: Direction Monitor (SSC2)

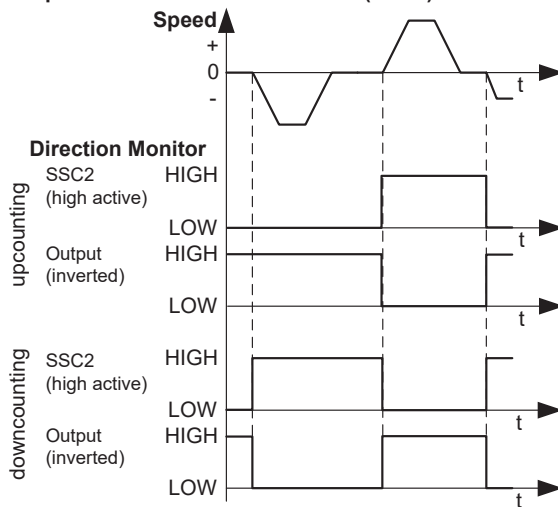

Parameters:

- Switching point (Monitoring Direction)
- Switching logic (high active, low active)
- Switching hysteresis
- Output function
- Output logic
- Output startup settings
- For more details, please refer to the IODD.

Output function: Standstill Monitor (SSC3)

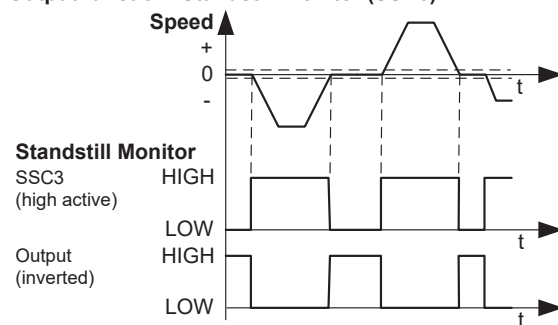

Parameters:

- Switching point (Standstill threshold)
- Switching logic (high active, low active)
- Switching hysteresis (Standstill threshold)
- Output function
- Output logic
- Output startup settings
- For more details, please refer to the IODD.

EB200E.IR-FN.8L2C5.008L

32...1024 pulses per revolution

Article number: 11705077

Dimensions

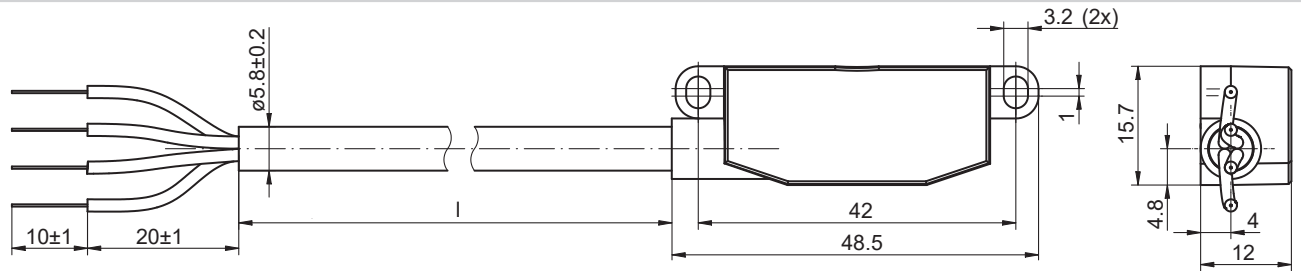

EB200E.IR-FN with cable and leads

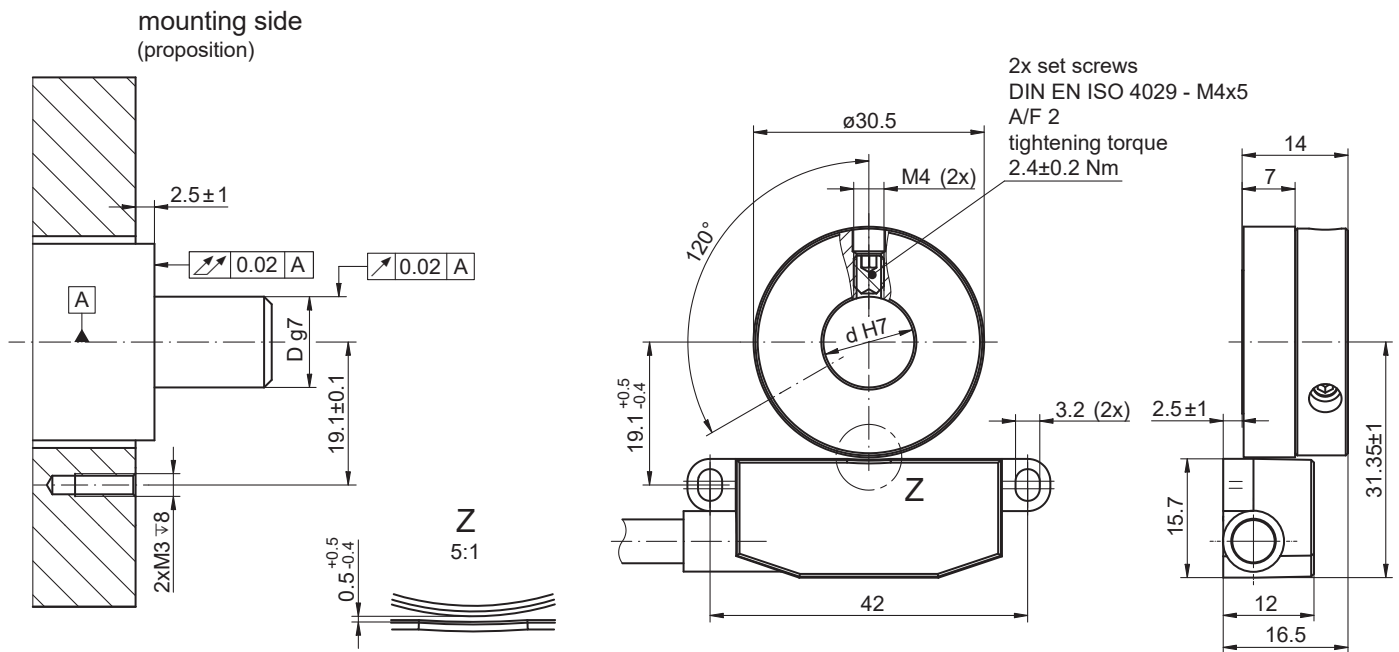

EB200E.IR-FN with EBS.R-FN032.S for screw mounting

EB200E.IR-FN.8L2C5.008L

32...1024 pulses per revolution

Article number: 11705077

Dimensions

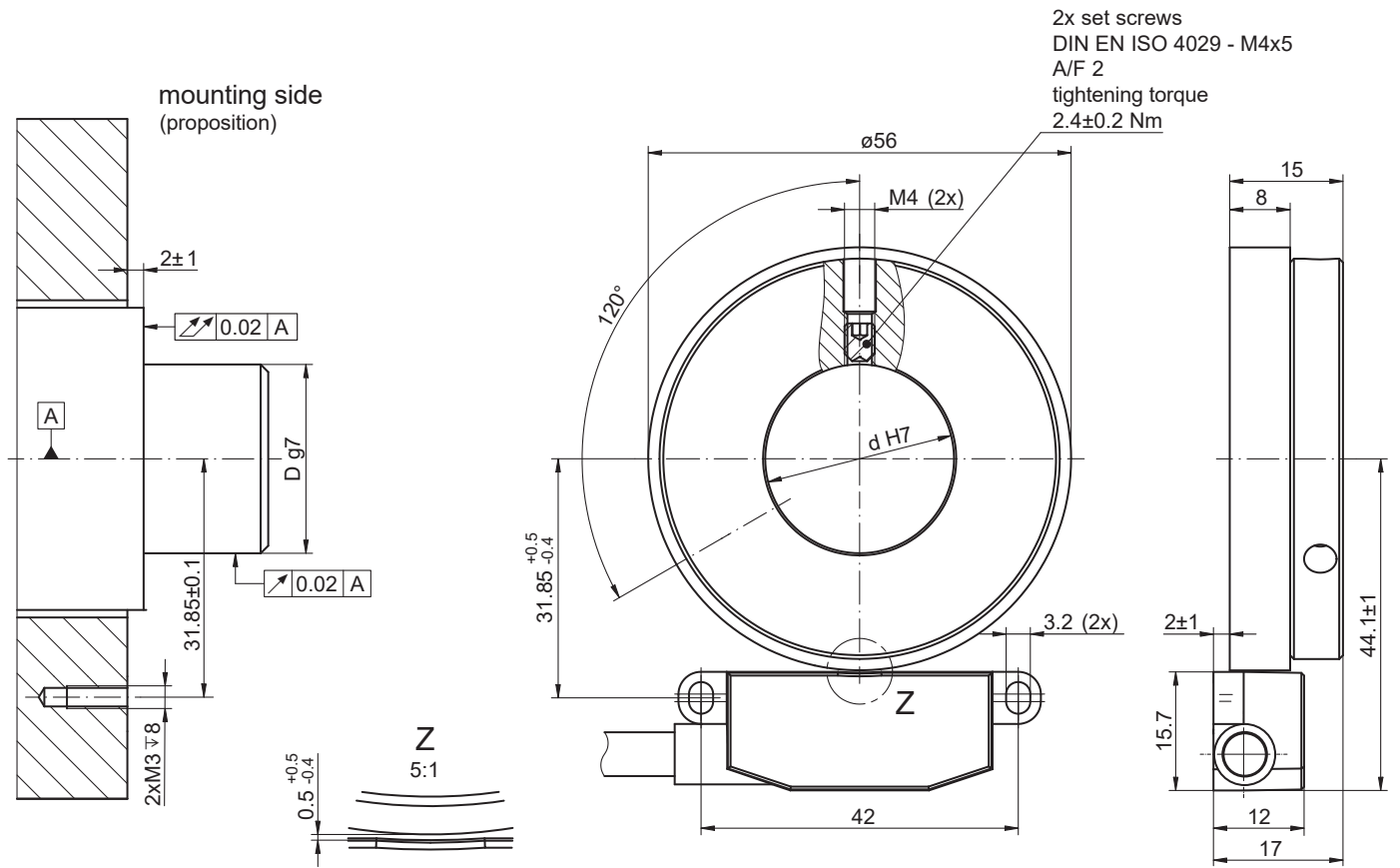

EB200E.IR-FN with EBS.R-FN064.S for screw mounting

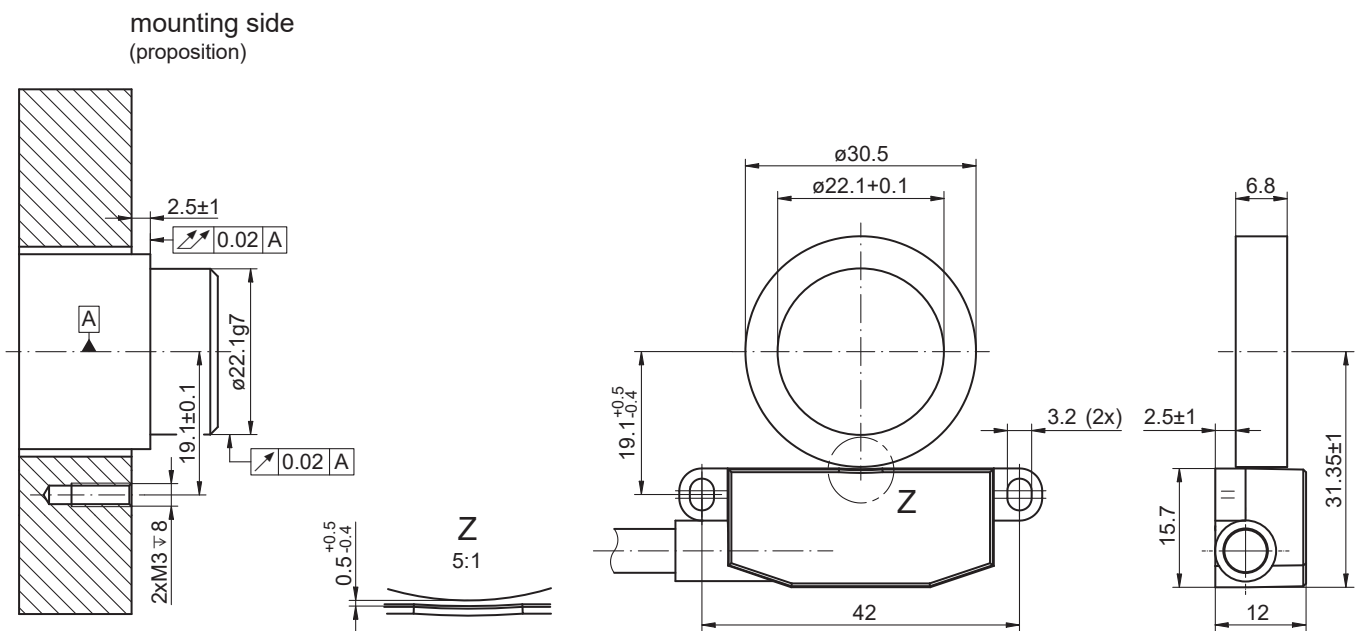

EB200E.IR-FN with EBS.R-FN032.B for bonding

Dimensions

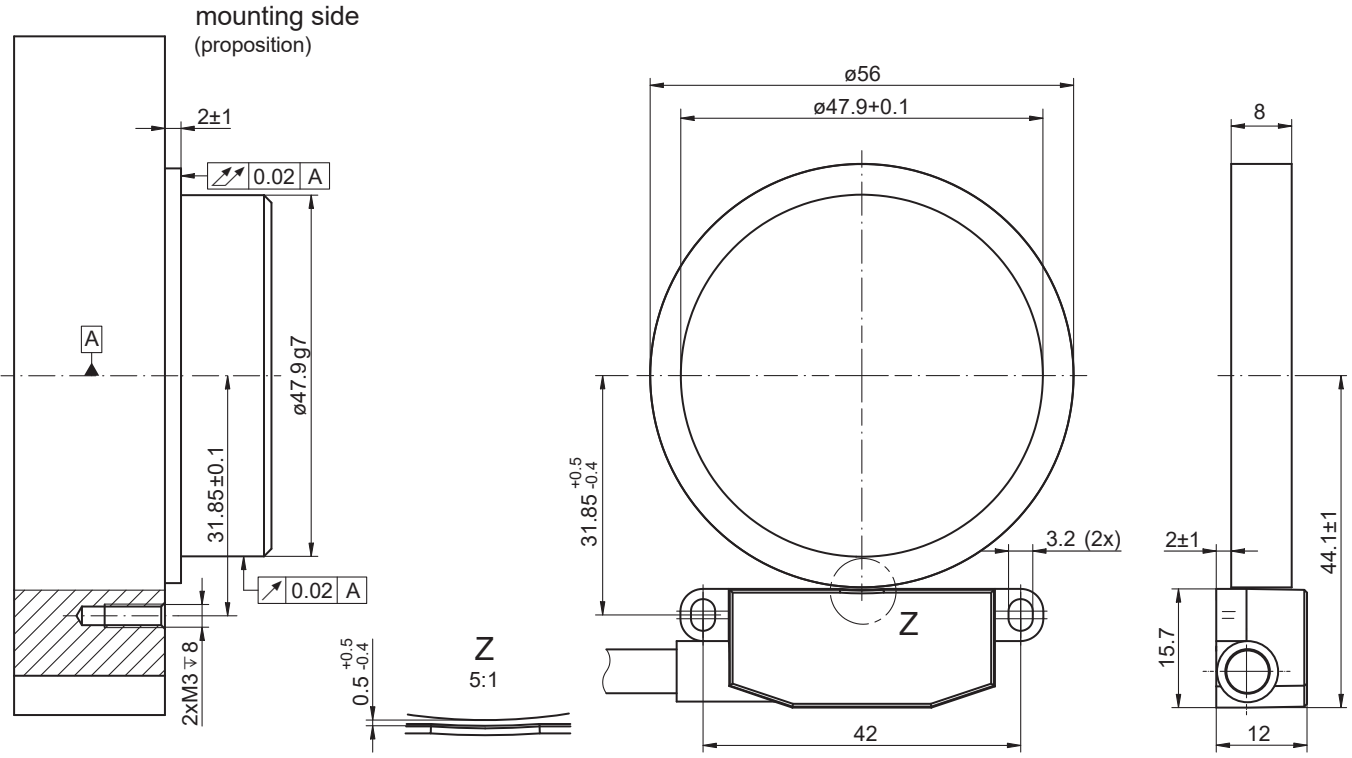

EB200E.IR-FN with EBS.R-FN064.B for bonding

EB200E.IR-FN.8L2C5.008L

32...1024 pulses per revolution

Article number: 11705077

Article number

Sensor

Article number	Typecode	Description
11705003	EB200E.IR-FN.8L2C2.008L	Cable 2 m
11705077	EB200E.IR-FN.8L2C5.008L	Cable 5 m
11705449	EB200E.IR-FN.8L2GN.008L	Connector M12 after 0.3 m cable outlet
11266072	EB200E.IR-FN.8L2E0.008L	Connector M8 on housing

Magnetic rotor (accessory, needs to be ordered separately)

Article number	Typecode	Description
11706601	EBS.R-FN032.S008.A14.P0031	32 poles, screw mounting, ID=8 mm, OD=31 mm
11721558	EBS.R-FN032.S010.A14.P0031	32 poles, screw mounting, ID=10 mm, OD=31 mm
11704973	EBS.R-FN032.S012.A14.P0031	32 poles, screw mounting, ID=12 mm, OD=31 mm
11704974	EBS.R-FN032.S014.A14.P0031	32 poles, screw mounting, ID=14 mm, OD=31 mm
11704975	EBS.R-FN064.S025.A15.P0056	64 poles, screw mounting, ID=25 mm, OD=56 mm
11729187	EBS.R-FN064.S1Z0.A15.P0056	64 poles, screw mounting, ID=25.4 mm, OD=56 mm
11705452	EBS.R-FN032.B022.N0A.P0031	32 poles, for bonding, ID=22.1 mm, OD=31 mm
11705527	EBS.R-FN032.B022.N0A.P0031_9503	32 poles, for bonding, ID=22.1 mm, OD=31 mm, 36 pieces
11705453	EBS.R-FN064.B048.N08.P0056	64 poles, for bonding, ID=47.9 mm, OD=56 mm
11705528	EBS.R-FN064.B048.N08.P0056_9502	64 poles, for bonding, ID=47.9 mm, OD=56 mm, 48 pieces

Possible pulse numbers

Sensor EB200E.IR Parameterizable interpolation	Magnetic rotor (32 poles) EBS.R-FN032	Magnetic rotor (64 poles) EBS.R-FN064
1-fold	32	64
2-fold	64	128
3-fold	96	192
4-fold	128	256
5-fold	160	320
8-fold	256	512
10-fold	320	640
12-fold	384	768
16-fold	512	1024

Accessories

Mounting accessories

11250175 Mounting kit EB200E

Programming accessories

11214576 SensControl

11234828 USB-C IO-Link Master