

**Overview**

- M12, female, A-coded; 8-poles; TPE-S, 200 cm, shielded, free cable end
- Dragchain capable
- Head A: IP65, IP68, IP69K
- Halogen free



**Technical data**

Side A	
Head A: Connection	M12
Head A: Angle cable outlet	90°
Head A: Gender	Female
Head A: Coding	A
Head A: No. of poles	8
Head A: LED	No
Head A: Width across flats	AF14
Head A: Tightening torque	0.6 Nm
Head A: Knurled nut material	Stainless steel (V4A)
Head A: Body color	Blue
Head A: Gasket material	EPDM
Labeling sleeve side A	No
Side B	
Head B: Connection	Open-ended wires
Labeling sleeve side B	No
Cables	
Cable length	200 cm
Length tolerance	+ 10 cm
Stripping length	60 mm
Shielded	Yes
Conductor structure	32 × 0.1 mm
External sheath: Material	TPE-S
External sheath: Color	Blue
Cable diameter	6.7 mm ± 5%
Wire cross section	0.25 mm <sup>2</sup>
Cable	
External sheath: Shore hardness	47 ± 5 D
Cable: Temperature range (mobile)	- 20 ...+ 105 °C
Cable: Temperature range (fixed)	- 40 ...+ 105 °C
Shielded	Yes
Shielding: Covering	approx. 85 %
Bending radius (fixed)	50.25 mm
Number of wires	8
Number and diameter of wires	8x0.25
Length tolerance	+ 10 cm

Cable	
Cable length	200 cm
Acceleration (C-track)	max. 2 m/s <sup>2</sup>
Bending radius (fixed)	min. 7.5 × outer diameter
Bending radius (mobile)	min. 10 × outer diameter
Cable weight	approx. 66 g/m
Conductor structure	32 × 0.1 mm
Cable diameter	6.7 mm ± 5%
Conductor: Material	Copper, bare
External sheath: Material	TPE-S
Insulation: Material	PP
Shielding: Material	Copper, tinned
No. of bending cycles (C-track)	approx. 2000000 Cycles
Nominal voltage	300 V AC
Paired stranding	No
Single wire diameter	0.1 mm
Cable: Test voltage	3 kV
Total stranding	8 wires strand around core-filler
Travel speed (C-track)	max. 3.3 m/s
Traversing path (horizontal)	max. 5 m
Wire cross section	0.25 mm <sup>2</sup>
Wire processing	No
Wire diameter incl. isolation	1.25 mm ± 5%
External sheath: Color	Blue
Electrical data	
Operating voltage	max. 30 V AC/DC
Nominal voltage	300 V AC
Contact resistance	max. 30 mOhm
Operating current per contact	max. 2 A
Mechanical data	
Head A: Degree of protection	IP65, IP68, IP69K
Bending radius (mobile)	min. 10 × outer diameter
Bending radius (fixed)	min. 7.5 × outer diameter
No. of bending cycles (C-track)	approx. 2000000 Cycles
Acceleration (C-track)	max. 2 m/s <sup>2</sup>
Travel speed (C-track)	max. 3.3 m/s

**Technical data**

**Environmental conditions**

Temperature range (mobile)	- 20 ...+ 105 °C
Temperature range (fixed)	- 40 ...+ 105 °C
Cable: Temperature range (fixed)	- 40 ...+ 105 °C
Dragchain capable	Yes
Head A: Chemical resistance	Chemical resistance tested according to ECOLAB. If other media are used, the material resistance must be tested according to the application.

**Environmental conditions**

Head A: Oil resistance	ASTM 1 oil, mineral oils, limited to hydraulic oils
Head A: Acid and alkali resistant	ECOLAB tested
Cable: Flame resistance	HB (UL 94)
Cable: Acid and alkali resistant	Good (FDA 21 178.3620, 178.3297, 177.1520, EU 10/2011)
Cable: Silicone-free	Yes

**Commercial data**

Eclass	27060311
--------	----------

**Side A**

**Technical drawing**

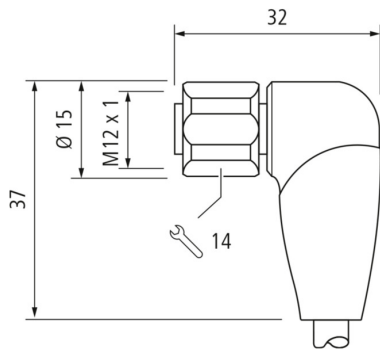

**Side B**

**Technical drawing**

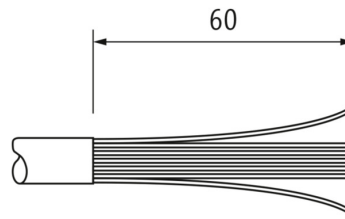

**Coding**

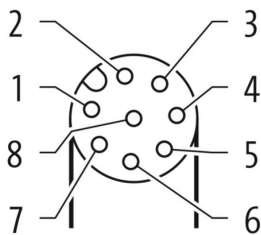

**Connection diagram**

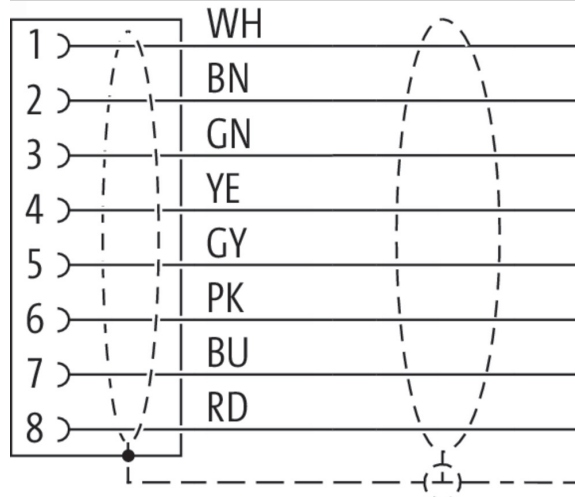

**Dimension drawing**

