

Overview

- M12, female, A-coded; 5-poles; TPE-S, 100 cm, free cable end
- Dragchain capable; suitable for robotics $\pm 180^\circ/\text{m}$; suitable for food & beverage
- Head A: IP65, IP68, IP69K
- ECOLAB tested
- Halogen free

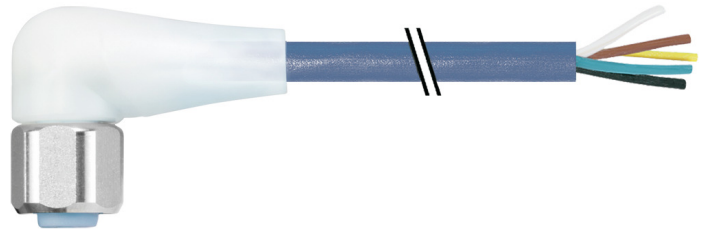

Technical data

Side A		Cable	
Head A: Connection	M12	Cable length	100 cm
Head A: Angle cable outlet	90°	Acceleration (C-track)	max. 10 m/s ²
Head A: Gender	Female	AWG	22
Head A: Coding	A	Bending radius (fixed)	min. 5 × outer diameter
Head A: No. of poles	5	Torsion speed	max. 35 cycles/min
Head A: LED	Yes	Bending radius (mobile)	min. 10 × outer diameter
Head A: LED switching status	PNP	Cable weight	approx. 35.2 g/m
Head A: Width across flats	AF14	Conductor structure	42 × 0.1 mm
Head A: Tightening torque	0.6 Nm	Cable diameter	5 mm ± 5%
Head A: Knurled nut material	Stainless steel (V4A)	Conductor: Material	Copper, bare
Head A: Body color	Transparent	External sheath: Material	TPE-S
Head A: Gasket material	EPDM	Insulation: Material	PP
Labeling sleeve side A	No	No. of bending cycles (C-track)	approx. 4000000 Cycles
Side B		Nominal voltage	300 V AC
Head B: Connection	Open-ended wires	No. of torsion cycles	approx. 2000000 Cycles
Labeling sleeve side B	No	Paired stranding	No
Cables		Single wire diameter	0.1 mm
Cable length	100 cm	Cable: Test voltage	3 kV
Length tolerance	+ 5 cm	Torsion stress in °	± 180 °/m
Stripping length	20 mm	Total stranding	5 wires strand around core-filler
Shielded	No	Travel speed (C-track)	max. 3 m/s
Conductor structure	42 × 0.1 mm	Traversing path (horizontal)	max. 10 m
AWG	22	Wire cross section	0.34 mm ²
External sheath: Material	TPE-S	Wire processing	No
External sheath: Color	Blue	Wire diameter incl. isolation	1.27 mm ± 5%
Cable diameter	5 mm ± 5%	External sheath: Color	Blue
Wire cross section	0.34 mm ²	Electrical data	
Cable		Operating voltage	24 V DC ± 25 %
Cable: Temperature range (mobile)	- 25 ...+ 105 °C	Nominal voltage	300 V AC
Cable: Temperature range (fixed)	- 40 ...+ 105 °C	Contact resistance	max. 30 mOhm
Shielded	No	Operating current per contact	max. 4 A
Bending radius (fixed)	25 mm	Mechanical data	
Number of wires	5	Head A: Degree of protection	IP65, IP68, IP69K
Number and diameter of wires	5x0.34	Bending radius (mobile)	min. 10 × outer diameter
Length tolerance	+ 5 cm	Bending radius (fixed)	min. 5 × outer diameter

Technical data

Mechanical data

No. of bending cycles (C-track)	approx. 4000000 Cycles
Torsion speed	max. 35 cycles/min
Torsion stress in °	± 180 °/m
No. of torsion cycles	approx. 2000000 Cycles
Acceleration (C-track)	max. 10 m/s ²
Travel speed (C-track)	max. 3 m/s

Environmental conditions

Temperature range (mobile)	- 25 ...+ 85 °C
Temperature range (fixed)	- 40 ...+ 85 °C
Cable: Temperature range (fixed)	- 40 ...+ 105 °C
Dragchain capable	Yes
Head A: Chemical resistance	Chemical resistance tested according to ECOLAB. If other media are used, the material resistance must be tested according to the application.

Environmental conditions

Head A: Flame resistance	HB (UL 94)
Head A: Oil resistance	ASTM 1 oil, mineral oils, limited to hydraulic oils
Head A: Acid and alkali resistant	ECOLAB tested
Head A: Pollution degree	3
Cable: Chemical resistance	ECOLAB material resistance test passed
Cable: Acid and alkali resistant	Good (FDA 21 178.3620, 178.3297, 177.1520, EU 10/2011)
Cable: Silicone-free	Yes

Commercial data

Eclass	27060311
--------	----------

Side A

Technical drawing

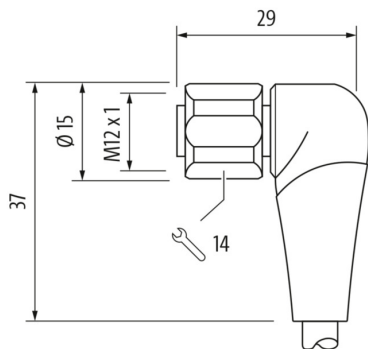

Side B

Technical drawing

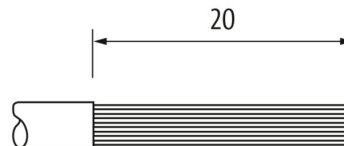

Coding

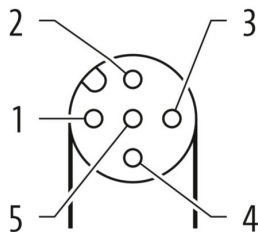

Connection diagram

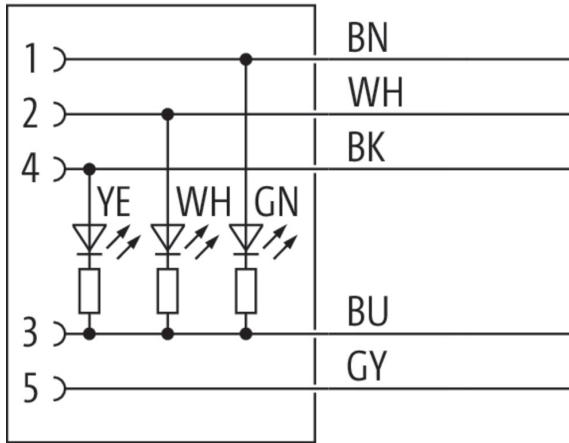

Dimension drawing

