

**Vue d'ensemble**

- M12, female, A-coded, 5-poles; PUR, 2500 cm, free cable end
- Dragchain capable; suitable for robotics  $\pm 180^\circ/\text{m}$
- Head A: IP65, IP66K, IP67
- Cable: good resistance against chemicals, flames, oils



**Caractéristiques techniques**

Side A		Cable	
Head A: Connection	M12	Acceleration (C-track)	max. 10 m/s <sup>2</sup>
Head A: Angle cable outlet	0°	AWG	22
Head A: Gender	Female	Bending radius (fixed)	min. 5 × outer diameter
Head A: Coding	A	Torsion speed	max. 35 cycles/min
Head A: No. of poles	5	Bending radius (mobile)	min. 10 × outer diameter
Head A: LED	Oui	Cable type	3
Head A: LED switching status	PNP	Cable weight	approx. 41,8 g/m
Head A: Width across flats	AF13	Conductor structure	42 × 0,1 mm
Head A: Tightening torque	0,6 Nm	Cable diameter	4,8 mm ± 5%
Head A: Knurled nut material	Zinc-pressure die casting, surface Ni	Conductor: Material	Copper, bare
Head A: Body color	Transparent	External sheath: Material	PUR
Head A: Gasket material	FKM	Insulation: Material	PP
Labeling sleeve side A	Yes	No. of bending cycles (C-track)	approx. 10000000 Cycles
<b>Side B</b>		Nominal voltage	300 V
Head B: Connection	Open-ended wires	No. of torsion cycles	approx. 2000000 Cycles
Labeling sleeve side B	Yes	Paired stranding	No
<b>Cables</b>		Single wire diameter	0,1 mm
Cable length	2500 cm	Cable: Test voltage	2,5 kV
Length tolerance	± 37,5 cm	Torsion stress in °	± 180 °/m
Stripping length	20 mm	Total stranding	5 wires strand around core-filler
Shielded	No	Travel speed (C-track)	max. 3 m/s
Conductor structure	42 × 0,1 mm	Traversing path (horizontal)	max. 10 m
AWG	22	Wire cross section	0,34 mm <sup>2</sup>
External sheath: Material	PUR	Wire processing	No
External sheath: Color	Black	Wire diameter incl. isolation	1,25 mm ± 5%
Cable diameter	4,8 mm ± 5%	External sheath: Color	Black
Wire cross section	0,34 mm <sup>2</sup>	<b>Données électriques</b>	
<b>Cable</b>		Operating voltage	24 V DC ± 25 %
Cable: Temperature range (mobile)	- 25 ...+ 80 °C	Nominal voltage	300 V
Cable: Temperature range (fixed)	- 40 ...+ 80 °C	Contact resistance	max. 30 mOhm
Shielded	No	Operating current per contact	max. 4 A
Bending radius (fixed)	24 mm	<b>Données mécaniques</b>	
Number of wires	5	Head A: Degree of protection	IP65, IP66K, IP67
Number and diameter of wires	5x0,34	Bending radius (mobile)	min. 10 × outer diameter
Length tolerance	± 37,5 cm	Bending radius (fixed)	min. 5 × outer diameter
Cable length	2500 cm	No. of bending cycles (C-track)	approx. 10000000 Cycles
		Torsion speed	max. 35 cycles/min

2024-07-16 Les caractéristiques du produit et les données techniques spécifiées n'impliquent aucune garantie. Toute modification technique réservée.

**Caractéristiques techniques**

**Données mécaniques**

Torsion stress in °	± 180 °/m
No. of torsion cycles	approx. 2000000 Cycles
Acceleration (C-track)	max. 10 m/s <sup>2</sup>
Travel speed (C-track)	max. 3 m/s

**Conditions ambiantes**

Temperature range (mobile)	- 25 ...+ 80 °C
Temperature range (fixed)	- 25 ...+ 80 °C
Cable: Temperature range (fixed)	- 40 ...+ 80 °C
Dragchain capable	Oui
Head A: Chemical resistance	No

**Conditions ambiantes**

Head A: Flame resistance	HB (UL 94)
Head A: Oil resistance	ASTM 1 oil, mineral oils, limited to hydraulic oils
Head A: Acid and alkali resistant	No
Head A: Pollution degree	3
Cable: Chemical resistance	Good (DIN EN 60811-404)
Cable: Flame resistance	Conform UL 1581 §1090 (H), CSA FT2, IEC 60332-2-2
Cable: Oil resistance	Good (DIN EN 60811-404)
Cable: Silicone-free	Oui

**Commercial data**

Eclass	27060311
--------	----------

**Side A**

**Technical drawing**

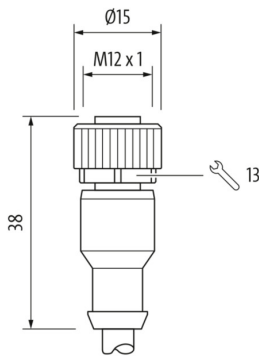

**Side B**

**Technical drawing**

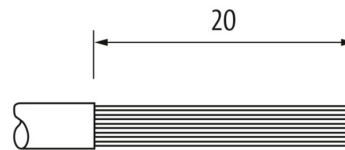

**Coding**

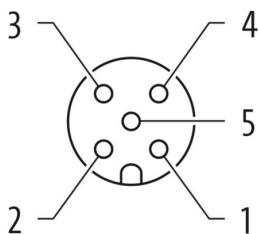

**Schéma de raccordement**

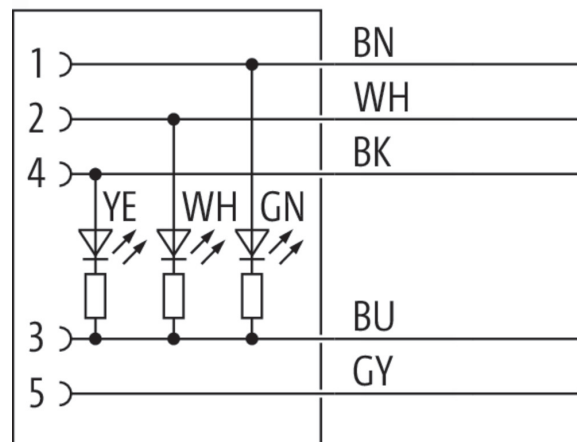

Dessin d'encombrement

