

Overview

- M12, female, A-coded; 5-poles; TPE-S, 1000 cm, shielded, free cable end
- Dragchain capable; suitable for robotics $\pm 180^\circ/\text{m}$; suitable for food & beverage
- Head A: IP65, IP68, IP69K
- ECOLAB tested
- Halogen free



Technical data

Side A		Cable	
Head A: Connection	M12	Number and diameter of wires	5x0.34
Head A: Angle cable outlet	90°	Length tolerance	± 15 cm
Head A: Gender	Female	Cable length	1000 cm
Head A: Coding	A	Acceleration (C-track)	max. 10 m/s ²
Head A: No. of poles	5	AWG	22
Head A: LED	No	Bending radius (fixed)	min. 5 × outer diameter
Head A: Width across flats	AF14	Torsion speed	max. 35 cycles/min
Head A: Tightening torque	0.6 Nm	Bending radius (mobile)	min. 10 × outer diameter
Head A: Knurled nut material	Stainless steel (V4A)	Cable weight	approx. 51.7 g/m
Head A: Body color	Blue	Conductor structure	42 × 0.1 mm
Head A: Gasket material	EPDM	Cable diameter	5.9 mm $\pm 5\%$
Labeling sleeve side A	No	Conductor: Material	Copper, bare
Side B		External sheath: Material	TPE-S
Head B: Connection	Open-ended wires	Insulation: Material	PP
Labeling sleeve side B	No	Shielding: Material	Copper, tinned
Cables		No. of bending cycles (C-track)	approx. 4000000 Cycles
Cable length	1000 cm	Nominal voltage	300 V AC
Length tolerance	± 15 cm	No. of torsion cycles	approx. 2000000 Cycles
Stripping length	20 mm	Paired stranding	No
Shielded	Yes	Single wire diameter	0.1 mm
Conductor structure	42 × 0.1 mm	Cable: Test voltage	3 kV
AWG	22	Torsion stress in °	$\pm 180^\circ/\text{m}$
External sheath: Material	TPE-S	Total stranding	5 wires strand around core-filler
External sheath: Color	Blue	Travel speed (C-track)	max. 3 m/s
Cable diameter	5.9 mm $\pm 5\%$	Traversing path (horizontal)	max. 10 m
Wire cross section	0.34 mm ²	Wire cross section	0.34 mm ²
Cable		Wire processing	No
Cable: Temperature range (mobile)	- 25 ...+ 105 °C	Wire diameter incl. isolation	1.27 mm $\pm 5\%$
Cable: Temperature range (fixed)	- 40 ...+ 105 °C	External sheath: Color	Blue
Operating voltage (only UL listed)	30 V AC/DC	Electrical data	
Shielded	Yes	Operating voltage	max. 60 V AC/DC
Shielding: Covering	approx. 85 %	Operating voltage (only UL listed)	30 V AC/DC
Bending radius (fixed)	29.5 mm	Nominal voltage	300 V AC
Number of wires	5	Contact resistance	max. 30 mOhm

The product features and technical data specified do not express or imply any warranty. Technical modifications subject to change.

Technical data

Electrical data

Operating current per contact max. 4 A

Mechanical data

Head A: Degree of protection IP65, IP68, IP69K
 Bending radius (mobile) min. 10 × outer diameter
 Bending radius (fixed) min. 5 × outer diameter
 No. of bending cycles (C-track) approx. 4000000 Cycles
 Torsion speed max. 35 cycles/min
 Torsion stress in ° ± 180 °/m
 No. of torsion cycles approx. 2000000 Cycles
 Acceleration (C-track) max. 10 m/s²
 Travel speed (C-track) max. 3 m/s

Environmental conditions

Temperature range (mobile) - 25 ...+ 105 °C
 Temperature range (fixed) - 40 ...+ 105 °C
 Cable: Temperature range (fixed) - 40 ...+ 105 °C

Environmental conditions

Dragchain capable Yes
 Head A: Chemical resistance Chemical resistance tested according to ECOLAB. If other media are used, the material resistance must be tested according to the application.
 Head A: Flame resistance HB (UL 94)
 Head A: Oil resistance ASTM 1 oil, mineral oils, limited to hydraulic oils
 Head A: Acid and alkali resistant ECOLAB tested
 Head A: Pollution degree 3
 Cable: Chemical resistance ECOLAB material resistance test passed
 Cable: Acid and alkali resistant Good (FDA 21 178.3620, 178.3297, 177.1520, EU 10/2011)
 Cable: Silicone-free Yes

Commercial data

Eclass 27060311

Side A

Coding

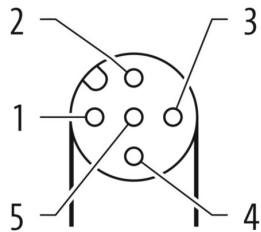

Side B

Technical drawing

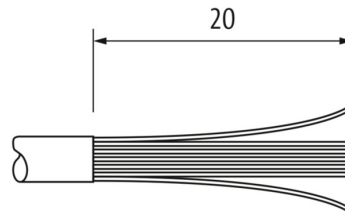

Connection diagram

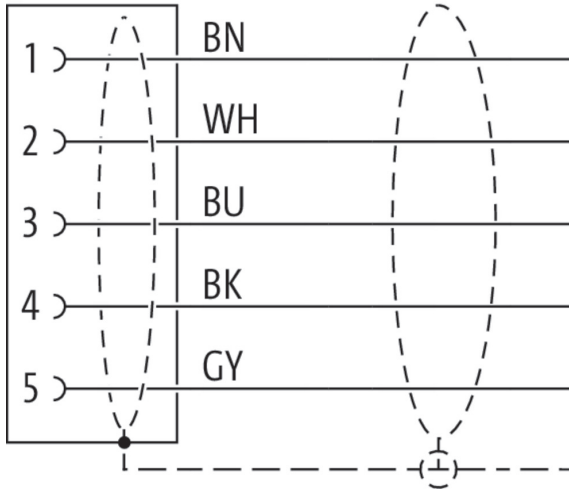

Dimension drawing

