

Overview

- M12, female, A-coded, 5-poles; PUR, 200 cm, shielded, free cable end
- Dragchain capable
- Head A: IP65, IP66K, IP67
- Cable: good resistance against chemicals, flames, oils
- Halogen free



Technical data

Side A

| | |
|------------------------------|---------------------------------------|
| Head A: Connection | M12 |
| Head A: Angle cable outlet | 0° |
| Head A: Gender | Female |
| Head A: Coding | A |
| Head A: No. of poles | 5 |
| Head A: LED | No |
| Head A: Width across flats | AF13 |
| Head A: Tightening torque | 0.6 Nm |
| Head A: Knurled nut material | Zinc-pressure die casting, surface Ni |
| Head A: Body color | Black |
| Head A: Gasket material | FKM |
| Labeling sleeve side A | Yes |

Side B

| | |
|------------------------|------------------|
| Head B: Connection | Open-ended wires |
| Labeling sleeve side B | Yes |

Cables

| | |
|---------------------------|----------------------|
| Cable length | 200 cm |
| Length tolerance | + 10 cm |
| Stripping length | 20 mm |
| Shielded | Yes |
| Conductor structure | 42 × 0.1 mm |
| AWG | 22 |
| External sheath: Material | PUR |
| External sheath: Color | Black |
| Cable diameter | 5.6 mm ± 5% |
| Wire cross section | 0.34 mm ² |

Cable

| | |
|------------------------------------|-----------------|
| Cable: Temperature range (mobile) | - 25 ...+ 80 °C |
| Cable: Temperature range (fixed) | - 40 ...+ 80 °C |
| Operating voltage (only UL listed) | 30 V AC/DC |
| Shielded | Yes |
| Shielding: Covering | approx. 80 % |
| Bending radius (fixed) | 28 mm |
| Number of wires | 5 |

Cable

| | |
|---------------------------------|---|
| Number and diameter of wires | 5x0.34 |
| Length tolerance | + 10 cm |
| Cable length | 200 cm |
| Acceleration (C-track) | max. 5 m/s ² |
| AWG | 22 |
| Bending radius (fixed) | min. 5 × outer diameter |
| Torsion speed | max. 35 cycles/min |
| Bending radius (mobile) | min. 10 × outer diameter |
| Cable type | 3 |
| Cable weight | approx. 57.2 g/m |
| Conductor structure | 42 × 0.1 mm |
| Cable diameter | 5.6 mm ± 5% |
| Conductor: Material | Copper, bare |
| External sheath: Material | PUR |
| Insulation: Material | PP |
| Shielding: Material | Copper, tinned |
| No. of bending cycles (C-track) | approx. 500000 Cycles |
| Nominal voltage | 300 V |
| No. of torsion cycles | approx. 2000000 Cycles |
| Paired stranding | No |
| Single wire diameter | 0.1 mm |
| Cable: Test voltage | 2 kV AC core-core ; 2 kV AC core-shield |
| Torsion stress in ° | ± 30 °/m |
| Total stranding | 5 wires strand around core-filler |
| Travel speed (C-track) | max. 3.3 m/s |
| Traversing path (horizontal) | max. 5 m |
| Wire cross section | 0.34 mm ² |
| Wire processing | No |
| Wire diameter incl. isolation | 1.25 mm ± 5% |
| External sheath: Color | Black |

Electrical data

| | |
|------------------------------------|-----------------|
| Operating voltage | max. 60 V AC/DC |
| Operating voltage (only UL listed) | 30 V AC/DC |
| Nominal voltage | 300 V |
| Contact resistance | max. 30 mOhm |

Technical data

Electrical data

Operating current per contact max. 4 A

Mechanical data

Head A: Degree of protection IP65, IP66K, IP67

Bending radius (mobile) min. 10 × outer diameter

Bending radius (fixed) min. 5 × outer diameter

No. of bending cycles (C-track) approx. 5000000 Cycles

Torsion speed max. 35 cycles/min

Torsion stress in ° ± 30 °/m

No. of torsion cycles approx. 2000000 Cycles

Acceleration (C-track) max. 5 m/s²

Travel speed (C-track) max. 3.3 m/s

Environmental conditions

Temperature range (mobile) - 25 ...+ 80 °C

Temperature range (fixed) - 25 ...+ 80 °C

Environmental conditions

Cable: Temperature range (fixed) - 40 ...+ 80 °C

Dragchain capable Yes

Head A: Chemical resistance No

Head A: Flame resistance HB (UL 94)

Head A: Oil resistance ASTM 1 oil, mineral oils, limited to hydraulic oils

Head A: Acid and alkali resistant No

Head A: Pollution degree 3

Cable: Chemical resistance Good (DIN EN 60811-404)

Cable: Flame resistance Conform UL 1581 §1090 (H), CSA FT2, IEC 60332-2-2

Cable: Oil resistance Good (DIN EN 60811-404)

Cable: Silicone-free Yes

Commercial data

Eclass 27060311

Side A

Technical drawing

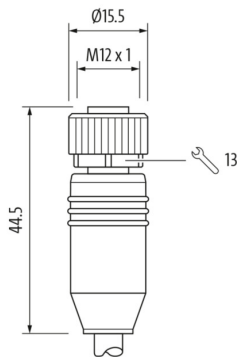

Side B

Technical drawing

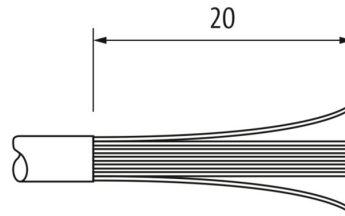

Coding

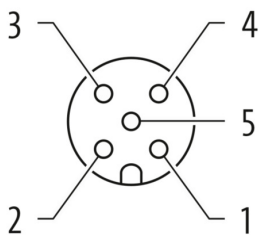

Connection diagram

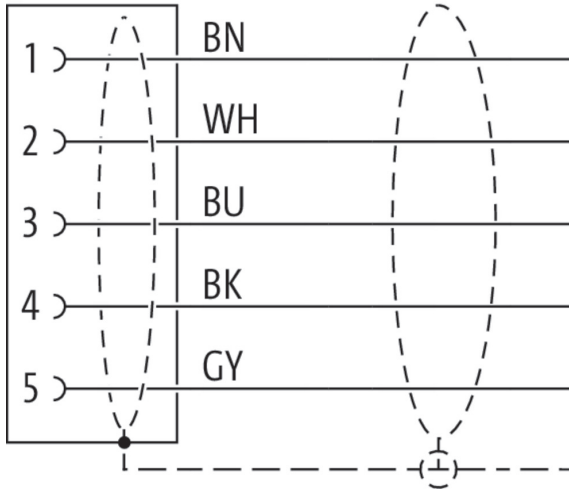

Dimension drawing

