

Overview

- M12, female, A-coded; 4-poles; TPE-S, 1500 cm, shielded, free cable end
- Dragchain capable; suitable for robotics $\pm 180^\circ/\text{m}$; suitable for food & beverage
- Head A: IP65, IP68, IP69K
- ECOLAB tested
- Halogen free



Technical data

Side A	
Head A: Connection	M12
Head A: Angle cable outlet	90°
Head A: Gender	Female
Head A: Coding	A
Head A: No. of poles	4
Head A: LED	No
Head A: Width across flats	AF14
Head A: Tightening torque	0.6 Nm
Head A: Knurled nut material	Stainless steel (V4A)
Head A: Body color	Blue
Head A: Gasket material	EPDM
Labeling sleeve side A	No
Side B	
Head B: Connection	Open-ended wires
Labeling sleeve side B	No
Cables	
Cable length	1500 cm
Length tolerance	± 22.5 cm
Stripping length	20 mm
Shielded	Yes
Conductor structure	42 \times 0.1 mm
AWG	22
External sheath: Material	TPE-S
External sheath: Color	Blue
Cable diameter	5.6 mm \pm 5%
Wire cross section	0.34 mm ²
Cable	
Cable: Temperature range (mobile)	- 25 ...+ 105 °C
Cable: Temperature range (fixed)	- 40 ...+ 105 °C
Operating voltage (only UL listed)	30 V AC/DC
Shielded	Yes
Shielding: Covering	approx. 85 %
Bending radius (fixed)	28 mm
Number of wires	4

Cable	
Number and diameter of wires	4x0.34
Length tolerance	± 22.5 cm
Cable length	1500 cm
Acceleration (C-track)	max. 10 m/s ²
AWG	22
Bending radius (fixed)	min. 5 \times outer diameter
Torsion speed	max. 35 cycles/min
Bending radius (mobile)	min. 10 \times outer diameter
Cable weight	approx. 45.1 g/m
Conductor structure	42 \times 0.1 mm
Cable diameter	5.6 mm \pm 5%
Conductor: Material	Copper, bare
External sheath: Material	TPE-S
Insulation: Material	PP
Shielding: Material	Copper, tinned
No. of bending cycles (C-track)	approx. 4000000 Cycles
Nominal voltage	300 V AC
No. of torsion cycles	approx. 2000000 Cycles
Paired stranding	No
Single wire diameter	0.1 mm
Cable: Test voltage	3 kV
Torsion stress in °	$\pm 180^\circ/\text{m}$
Total stranding	4 wires strand
Travel speed (C-track)	max. 3 m/s
Traversing path (horizontal)	max. 10 m
Wire cross section	0.34 mm ²
Wire processing	No
Wire diameter incl. isolation	1.27 mm \pm 5%
External sheath: Color	Blue
Electrical data	
Operating voltage	max. 60 V AC/DC
Operating voltage (only UL listed)	30 V AC/DC
Nominal voltage	300 V AC
Contact resistance	max. 30 mOhm

Technical data

Electrical data

Operating current per contact max. 4 A

Mechanical data

Head A: Degree of protection IP65, IP68, IP69K
 Bending radius (mobile) min. 10 × outer diameter
 Bending radius (fixed) min. 5 × outer diameter
 No. of bending cycles (C-track) approx. 4000000 Cycles
 Torsion speed max. 35 cycles/min
 Torsion stress in ° ± 180 °/m
 No. of torsion cycles approx. 2000000 Cycles
 Acceleration (C-track) max. 10 m/s²
 Travel speed (C-track) max. 3 m/s

Environmental conditions

Temperature range (mobile) - 25 ...+ 105 °C
 Temperature range (fixed) - 40 ...+ 105 °C
 Cable: Temperature range (fixed) - 40 ...+ 105 °C

Environmental conditions

Dragchain capable Yes
 Head A: Chemical resistance Chemical resistance tested according to ECOLAB. If other media are used, the material resistance must be tested according to the application.
 Head A: Flame resistance HB (UL 94)
 Head A: Oil resistance ASTM 1 oil, mineral oils, limited to hydraulic oils
 Head A: Acid and alkali resistant ECOLAB tested
 Head A: Pollution degree 3
 Cable: Chemical resistance ECOLAB material resistance test passed
 Cable: Acid and alkali resistant Good (FDA 21 178.3620, 178.3297, 177.1520, EU 10/2011)
 Cable: Silicone-free Yes

Commercial data

Eclass 27060311

Side A

Coding

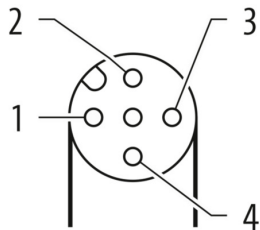

Side B

Technical drawing

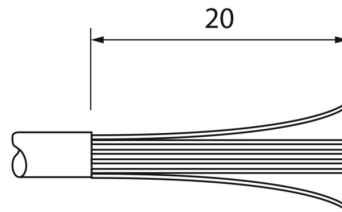

Connection diagram

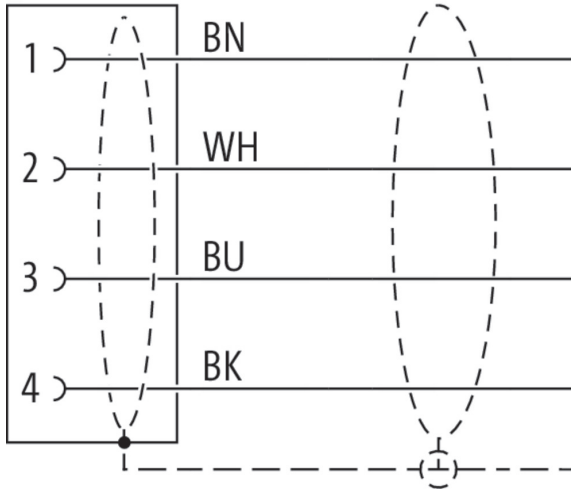

Dimension drawing

