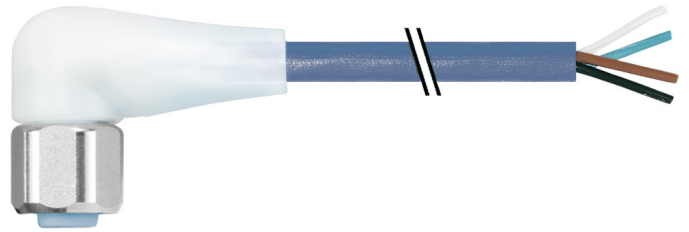

Overview

- M12, female, A-coded; 4-poles; TPE-S, 300 cm, free cable end
- Dragchain capable; suitable for robotics $\pm 180^\circ/\text{m}$; suitable for food & beverage
- Head A: IP65, IP68, IP69K
- ECOLAB tested
- Halogen free

Technical data
Side A

Head A: Connection	M12
Head A: Angle cable outlet	90°
Head A: Gender	Female
Head A: Coding	A
Head A: No. of poles	4
Head A: LED	Yes
Head A: LED switching status	PNP
Head A: Width across flats	AF14
Head A: Tightening torque	0.6 Nm
Head A: Knurled nut material	Stainless steel (V4A)
Head A: Body color	Transparent
Head A: Gasket material	EPDM
Labeling sleeve side A	No

Side B

Head B: Connection	Open-ended wires
Labeling sleeve side B	No

Cables

Cable length	300 cm
Length tolerance	+ 10 cm
Stripping length	20 mm
Shielded	No
Conductor structure	42 × 0.1 mm
AWG	22
External sheath: Material	TPE-S
External sheath: Color	Blue
Cable diameter	4.7 mm \pm 5%
Wire cross section	0.34 mm ²

Cable

Cable: Temperature range (mobile)	- 25 ...+ 105 °C
Cable: Temperature range (fixed)	- 40 ...+ 105 °C
Operating voltage (only UL listed)	30 V AC/DC
Shielded	No
Bending radius (fixed)	23.5 mm
Number of wires	4

Cable

Number and diameter of wires	4x0.34
Length tolerance	+ 10 cm
Cable length	300 cm
Acceleration (C-track)	max. 10 m/s ²
AWG	22
Bending radius (fixed)	min. 5 × outer diameter
Torsion speed	max. 35 cycles/min
Bending radius (mobile)	min. 10 × outer diameter
Cable weight	approx. 29.7 g/m
Conductor structure	42 × 0.1 mm
Cable diameter	4.7 mm \pm 5%
Conductor: Material	Copper, bare
External sheath: Material	TPE-S
Insulation: Material	PP
No. of bending cycles (C-track)	approx. 4000000 Cycles
Nominal voltage	300 V AC
No. of torsion cycles	approx. 2000000 Cycles
Paired stranding	No
Single wire diameter	0.1 mm
Cable: Test voltage	3 kV
Torsion stress in °	$\pm 180^\circ/\text{m}$
Total stranding	4 wires strand
Travel speed (C-track)	max. 3 m/s
Traversing path (horizontal)	max. 10 m
Wire cross section	0.34 mm ²
Wire processing	No
Wire diameter incl. isolation	1.27 mm \pm 5%
External sheath: Color	Blue

Electrical data

Operating voltage	24 V DC \pm 25 %
Operating voltage (only UL listed)	30 V AC/DC
Nominal voltage	300 V AC
Contact resistance	max. 30 mOhm
Operating current per contact	max. 4 A

Technical data

Mechanical data

Head A: Degree of protection	IP65, IP68, IP69K
Bending radius (mobile)	min. 10 × outer diameter
Bending radius (fixed)	min. 5 × outer diameter
No. of bending cycles (C-track)	approx. 4000000 Cycles
Torsion speed	max. 35 cycles/min
Torsion stress in °	± 180 °/m
No. of torsion cycles	approx. 2000000 Cycles
Acceleration (C-track)	max. 10 m/s ²
Travel speed (C-track)	max. 3 m/s

Environmental conditions

Temperature range (mobile)	- 25 ...+ 85 °C
Temperature range (fixed)	- 40 ...+ 85 °C
Cable: Temperature range (fixed)	- 40 ...+ 105 °C

Environmental conditions

Dragchain capable	Yes
Head A: Chemical resistance	Chemical resistance tested according to ECOLAB. If other media are used, the material resistance must be tested according to the application.
Head A: Flame resistance	HB (UL 94)
Head A: Oil resistance	ASTM 1 oil, mineral oils, limited to hydraulic oils
Head A: Acid and alkali resistant	ECOLAB tested
Head A: Pollution degree	3
Cable: Chemical resistance	ECOLAB material resistance test passed
Cable: Acid and alkali resistant	Good (FDA 21 178.3620, 178.3297, 177.1520, EU 10/2011)
Cable: Silicone-free	Yes

Commercial data

Eclass	27060311
--------	----------

Side A

Technical drawing

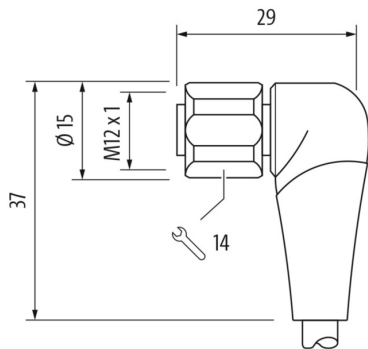

Side B

Technical drawing

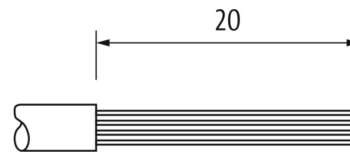

Coding

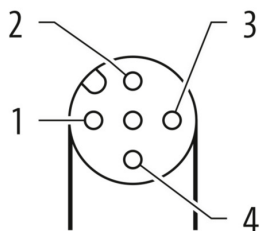

Connection diagram

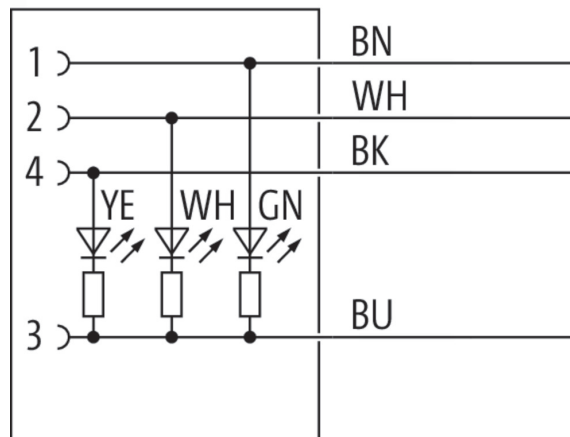

Dimension drawing

