

Overview

- M12, female, A-coded, 4-poles; PUR, 200 cm, free cable end
- Dragchain capable; suitable for robotics $\pm 180^\circ/\text{m}$
- Head A: IP65, IP66K, IP67
- Cable: good resistance against chemicals, flames, oils



Technical data

Side A

Head A: Connection	M12
Head A: Angle cable outlet	90°
Head A: Gender	Female
Head A: Coding	A
Head A: No. of poles	4
Head A: LED	Yes
Head A: LED switching status	PNP
Head A: Width across flats	AF13
Head A: Tightening torque	0.6 Nm
Head A: Knurled nut material	Zinc-pressure die casting, surface Ni
Head A: Body color	Transparent
Head A: Gasket material	FKM
Labeling sleeve side A	Yes

Side B

Head B: Connection	Open-ended wires
Labeling sleeve side B	Yes

Cables

Cable length	200 cm
Length tolerance	+ 10 cm
Stripping length	20 mm
Shielded	No
Conductor structure	42 × 0.1 mm
AWG	22
External sheath: Material	PUR
External sheath: Color	Black
Cable diameter	4.5 mm ± 5%
Wire cross section	0.34 mm ²

Cable

External sheath: Shore hardness	90 ± 5 A
Cable: Temperature range (mobile)	- 25 ...+ 80 °C
Cable: Temperature range (fixed)	- 40 ...+ 80 °C
Operating voltage (only UL listed)	30 V DC
Shielded	No
Bending radius (fixed)	22.5 mm
Number of wires	4

Cable

Number and diameter of wires	4x0.34
Length tolerance	+ 10 cm
Cable length	200 cm
Acceleration (C-track)	max. 10 m/s ²
AWG	22
Bending radius (fixed)	min. 5 × outer diameter
Torsion speed	max. 35 cycles/min
Bending radius (mobile)	min. 10 × outer diameter
Cable type	3
Cable weight	approx. 36.3 g/m
Conductor structure	42 × 0.1 mm
Cable diameter	4.5 mm ± 5%
Conductor: Material	Copper, bare
External sheath: Material	PUR
Insulation: Material	PP
No. of bending cycles (C-track)	approx. 10000000 Cycles
Nominal voltage	300 V
No. of torsion cycles	approx. 2000000 Cycles
Paired stranding	No
Single wire diameter	0.1 mm
Cable: Test voltage	2.5 kV
Torsion stress in °	± 180 °/m
Total stranding	4 wires strand
Travel speed (C-track)	max. 3 m/s
Traversing path (horizontal)	max. 10 m
Wire cross section	0.34 mm ²
Wire processing	No
Wire diameter incl. isolation	1.25 mm ± 5%
External sheath: Color	Black

Electrical data

Operating voltage	24 V DC ± 25 %
Operating voltage (only UL listed)	30 V DC
Nominal voltage	300 V
Contact resistance	max. 30 mOhm
Operating current per contact	max. 4 A

Technical data

Mechanical data

Head A: Degree of protection	IP65, IP66K, IP67
Bending radius (mobile)	min. 10 × outer diameter
Bending radius (fixed)	min. 5 × outer diameter
No. of bending cycles (C-track)	approx. 10000000 Cycles
Torsion speed	max. 35 cycles/min
Torsion stress in °	± 180 °/m
No. of torsion cycles	approx. 2000000 Cycles
Acceleration (C-track)	max. 10 m/s ²
Travel speed (C-track)	max. 3 m/s

Environmental conditions

Temperature range (mobile)	- 25 ...+ 80 °C
Temperature range (fixed)	- 25 ...+ 80 °C
Cable: Temperature range (fixed)	- 40 ...+ 80 °C

Environmental conditions

Dragchain capable	Yes
Head A: Chemical resistance	No
Head A: Flame resistance	HB (UL 94)
Head A: Oil resistance	ASTM 1 oil, mineral oils, limited to hydraulic oils
Head A: Acid and alkali resistant	No
Head A: Pollution degree	3
Cable: Chemical resistance	Good (DIN EN 60811-404)
Cable: Flame resistance	Conform UL 1581 §1090 (H), CSA FT2, IEC 60332-2-2
Cable: Oil resistance	Good (DIN EN 60811-404)
Cable: Silicone-free	Yes

Commercial data

Eclass	27060311
--------	----------

Side A

Technical drawing

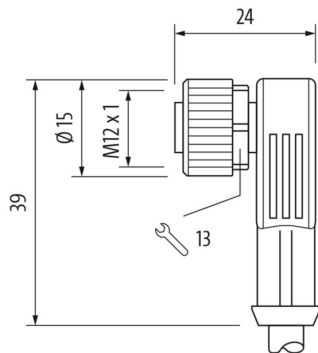

Side B

Technical drawing



Coding

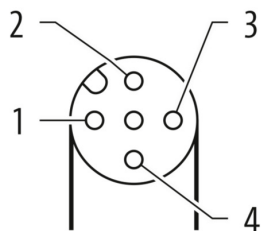

Connection diagram

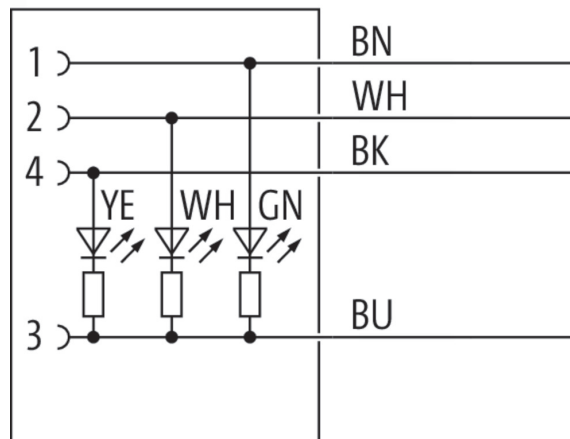

Dimension drawing

