

**Overview**

- M12, male, A-coded, 4-poles; PUR, 500 cm; M12, female, A-coded, 4-poles
- Dragchain capable; suitable for robotics  $\pm 180^\circ/\text{m}$
- Head A: IP65, IP66K, IP67; Head B: IP65, IP66K, IP67
- Cable: good resistance against chemicals, flames, oils
- Halogen free

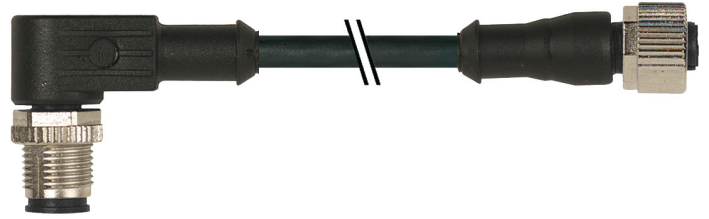

**Technical data**

**Side A**

Head A: Connection	M12
Head A: Angle cable outlet	90°
Head A: Gender	Male
Head A: Coding	A
Head A: No. of poles	4
Head A: LED	No
Head A: Width across flats	AF13
Head A: Tightening torque	0.6 Nm
Head A: Knurled nut material	Zinc-pressure die casting, surface Ni
Head A: Body color	Black
Labeling sleeve side A	Yes

**Side B**

Head B: Connection	M12
Head B: Angle cable outlet	0°
Head B: Gender	Female
Head B: Coding	A
Head B: No. of poles	4
Head B: LED	No
Head B: Width across flats	AF13
Head B: Tightening torque	0.6 Nm
Head B: Knurled nut material	Zinc-pressure die casting, surface Ni
Head B: Body color	Black
Head B: Gasket material	FKM
Labeling sleeve side B	Yes

**Cables**

Cable length	500 cm
Length tolerance	$\pm 7.5$ cm
Shielded	No
Conductor structure	42 $\times$ 0.1 mm
AWG	22
External sheath: Material	PUR
External sheath: Color	Black
Cable diameter	4.5 mm $\pm$ 5%
Wire cross section	0.34 mm <sup>2</sup>

**Cable**

External sheath: Shore hardness	90 $\pm$ 5 A
---------------------------------	--------------

**Cable**

Cable: Temperature range (mobile)	- 25 ...+ 80 °C
Cable: Temperature range (fixed)	- 40 ...+ 80 °C
Operating voltage (only UL listed)	30 V AC/DC
Shielded	No
Bending radius (fixed)	22.5 mm
Number of wires	4
Number and diameter of wires	4x0.34
Length tolerance	$\pm 7.5$ cm
Cable length	500 cm
Acceleration (C-track)	max. 10 m/s <sup>2</sup>
AWG	22
Bending radius (fixed)	min. 5 $\times$ outer diameter
Torsion speed	max. 35 cycles/min
Bending radius (mobile)	min. 10 $\times$ outer diameter
Cable type	3
Cable weight	approx. 36.3 g/m
Conductor structure	42 $\times$ 0.1 mm
Cable diameter	4.5 mm $\pm$ 5%
Conductor: Material	Copper, bare
External sheath: Material	PUR
Insulation: Material	PP
No. of bending cycles (C-track)	approx. 10000000 Cycles
Nominal voltage	300 V
No. of torsion cycles	approx. 2000000 Cycles
Paired stranding	No
Single wire diameter	0.1 mm
Cable: Test voltage	2.5 kV
Torsion stress in °	$\pm 180^\circ/\text{m}$
Total stranding	4 wires strand
Travel speed (C-track)	max. 3 m/s
Traversing path (horizontal)	max. 10 m
Wire cross section	0.34 mm <sup>2</sup>
Wire processing	No
Wire diameter incl. isolation	1.25 mm $\pm$ 5%

**Technical data**

**Cable**

External sheath: Color      Black

**Electrical data**

Operating voltage            max. 250 V AC/DC

Operating voltage (only UL listed)    30 V AC/DC

Nominal voltage            300 V

Contact resistance          max. 30 mOhm

Operating current per contact        max. 4 A

**Mechanical data**

Head A: Degree of protection        IP65, IP66K, IP67

Head B: Degree of protection        IP65, IP66K, IP67

Bending radius (mobile)            min. 10 × outer diameter

Bending radius (fixed)            min. 5 × outer diameter

No. of bending cycles (C-track)      approx. 10000000 Cycles

Torsion speed                    max. 35 cycles/min

Torsion stress in °                    ± 180 °/m

No. of torsion cycles                approx. 2000000 Cycles

Acceleration (C-track)            max. 10 m/s<sup>2</sup>

Travel speed (C-track)            max. 3 m/s

**Environmental conditions**

Temperature range (mobile)        - 25 ...+ 80 °C

Temperature range (fixed)        - 25 ...+ 80 °C

**Environmental conditions**

Cable: Temperature range (fixed)    - 40 ...+ 80 °C

Dragchain capable                Yes

Head A: Chemical resistance        No

Head A: Flame resistance        HB (UL 94)

Head A: Oil resistance            ASTM 1 oil, mineral oils, limited to hydraulic oils

Head A: Acid and alkali resistant    No

Head A: Pollution degree            3

Head B: Chemical resistance        No

Head B: Flame resistance        HB (UL 94)

Head B: Oil resistance            ASTM 1 oil, mineral oils, limited to hydraulic oils

Head B: Acid and alkali resistant    No

Head B: Pollution degree            3

Cable: Chemical resistance        Good (DIN EN 60811-404)

Cable: Flame resistance            Conform UL 1581 §1090 (H), CSA FT2, IEC 60332-2-2

Cable: Oil resistance            Good (DIN EN 60811-404)

Cable: Silicone-free                Yes

**Commercial data**

Eclass                                27060311

**Side A**

**Technical drawing**

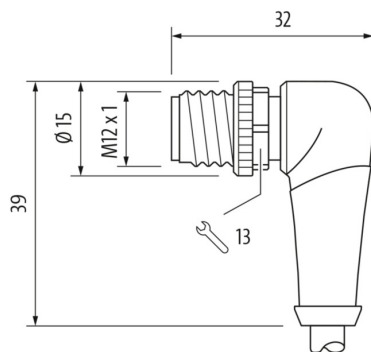

**Side A**

**Coding**

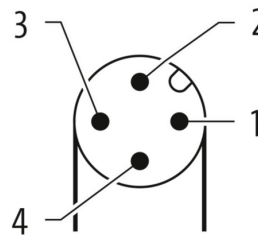

**Side B**

**Technical drawing**



**Dimension drawing**



**Coding**

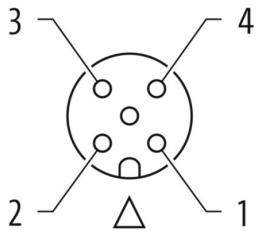

**Connection diagram**

